

# SINOSTAR

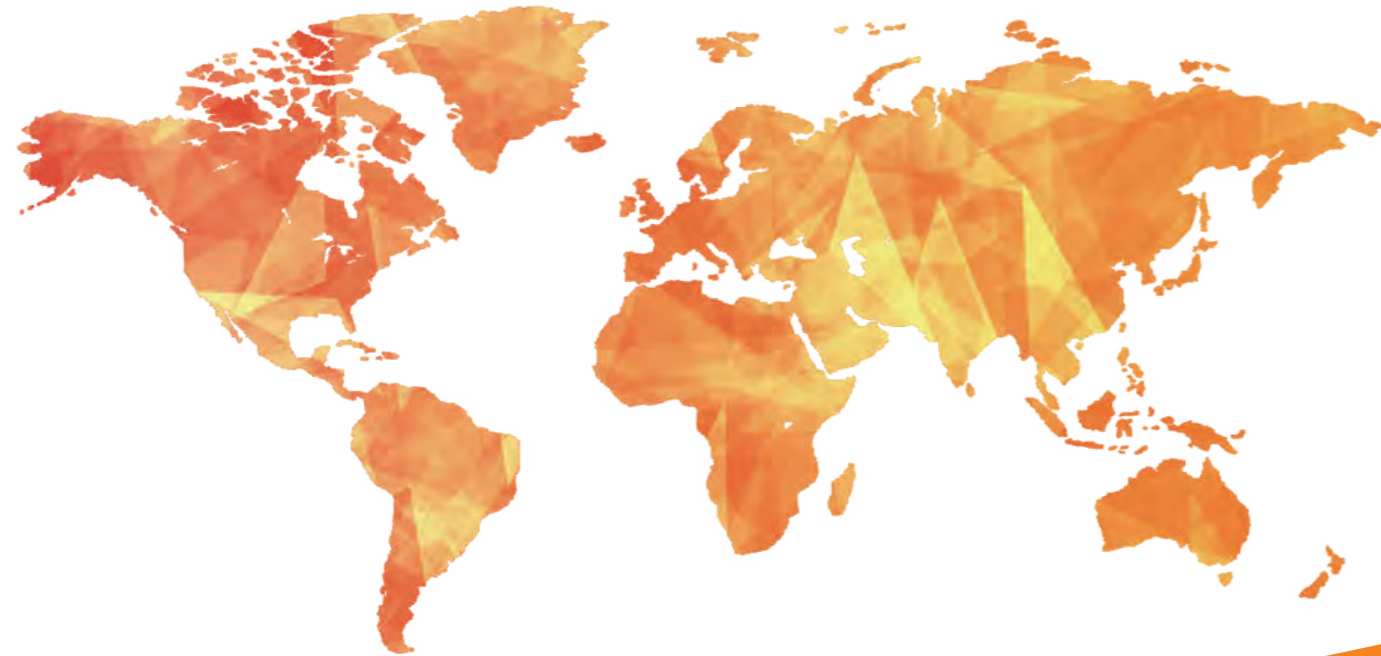

# SINOSTAR



LIGHT UP THE EARTH WITHOUT ELECTRICITY

SINOSTAR LIGHTING GROUP LTD.

5/F, #11 BUILDING, NO.24,  
FENJIANG NORTH, FOSHAN,  
CHINA, 528000

[www.SinoStar.net](http://www.SinoStar.net)  
Email: [sales@sinostarled.com](mailto:sales@sinostarled.com)

## SINOSTAR LIGHTING GROUP LTD.

# Contents

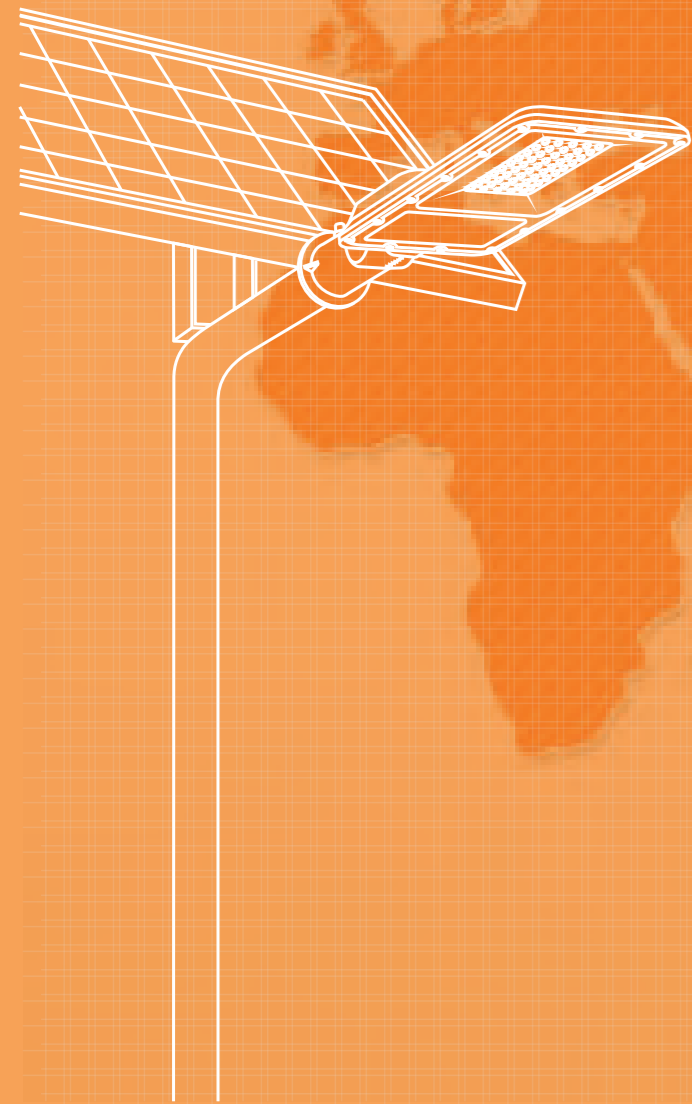

## PRODUCT INTRODUCTION

----- P02-P90

- Solar Street Light ----- P02-P28
- Solar Flood Light ----- P29-P44
- Work Light ----- P45-P52
- Street Light ----- P53-P60
- Flood Light ----- P61-P78
- High Bay Light ----- P79-P84

COMPETITIVE ADVANTAGES

- P85-P86
- Engineering Case ----- P87-P90

SOLAR STREET LIGHT SERIES



# LED SOLAR STREET LIGHT

## SOLAR STREET LIGHT SERIES

Battery		Solar Panel	
A	B	A	B
6A	6.5A	(5V/6V)/6W	5V/10W
12A	13A	(5V/6V)/12W	5V/15W
24A	26A	(5V/6V)/15W	5V/22W
36A	39A	(5V/6V)/22W	5V/30W
48A	52A	(5V/6V)/30W	5V/36W
60A	65A	(5V/6V)/36W	5V/45W
72A	78A	(5V/6V)/45W	5V/65W

Installation Height (H) and Distance (L)			Light Source
Number of batteries	Height (H)	Distance (L)	
2 batteries	4-5m	18-25m	980lm ±8% (Commen 12W LED) (Same as market marks 24W)
4 batteries	5-6m	20-30m	1800lm ±8% (Commen 20W LED) (Same as market marks 40W)
6 batteries	6-8m	25-35m	2600lm ±8% (Commen 30W LED) (Same as market marks 60W)
8 batteries	8-10m	35-45m	3200lm ±8% (Commen 40W LED) (Same as market marks 80W)
Lighting Time	All night lighting, the first 4 hrs full power lighting, the rest night lighting is intelligent power control.		



# SOLAR STREET LIGHT

## HM-R SERIES

R40/R60/R80/R100/R120/R150

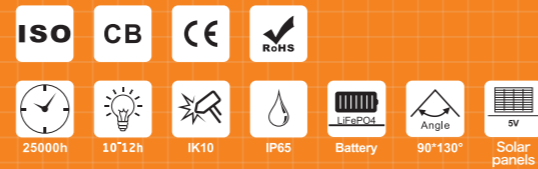

### PRODUCT ADVANTAGES AND FEATURES

- Grade A+ solar cell,each cell has a complete IV curve. Conversion efficiency is more than 21.3%.
- Lithium iron phosphate battery,the discharge depth reaches 95%. Under teh discharge ratio of less than 0.5C,service life is up to 13 years, with high safety factor.
- High lumen LED SMD,with 50,000 hrs life span.
- PC outdoor optical lens,high light transmittance.
- High quality aluminum magnesium alloy,anti-corrison,substantial, durable,artistic,practical.
- High craft manifesting production value of famous brand.
- Designed diamond face reflection process,super high efficiency reflection light source, effectively enhance the brightness of the illumination.



### SOLAR STREET LIGHT SERIES

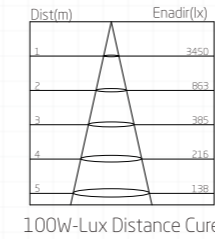
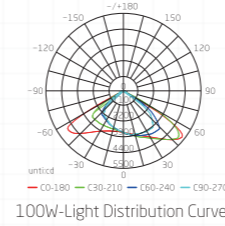

#### Product Technical Parameters

Model	Luminous	Battery	Solar Panel
HM-R40	170lm/W	3.2V/25Ah	(5V/6V)40W
HM-R60	170lm/W	12V/15Ah	(5V/6V)60W
HM-R80	170lm/W	12V/20Ah	(5V/6V)80W
HM-R100	170lm/W	3.2V/48Ah	(5V/6V)100W
HM-R120	170lm/W	3.2V/60Ah	(5V/6V)120W
HM-R150	170lm/W	3.2V/72Ah	(5V/6V)150W

**Lighting Time** The first 4 hrs full power lighting, the rest night lighting is intelligent power control; Use tuya or remote-controller switch on and off, also can adjust the brightness.

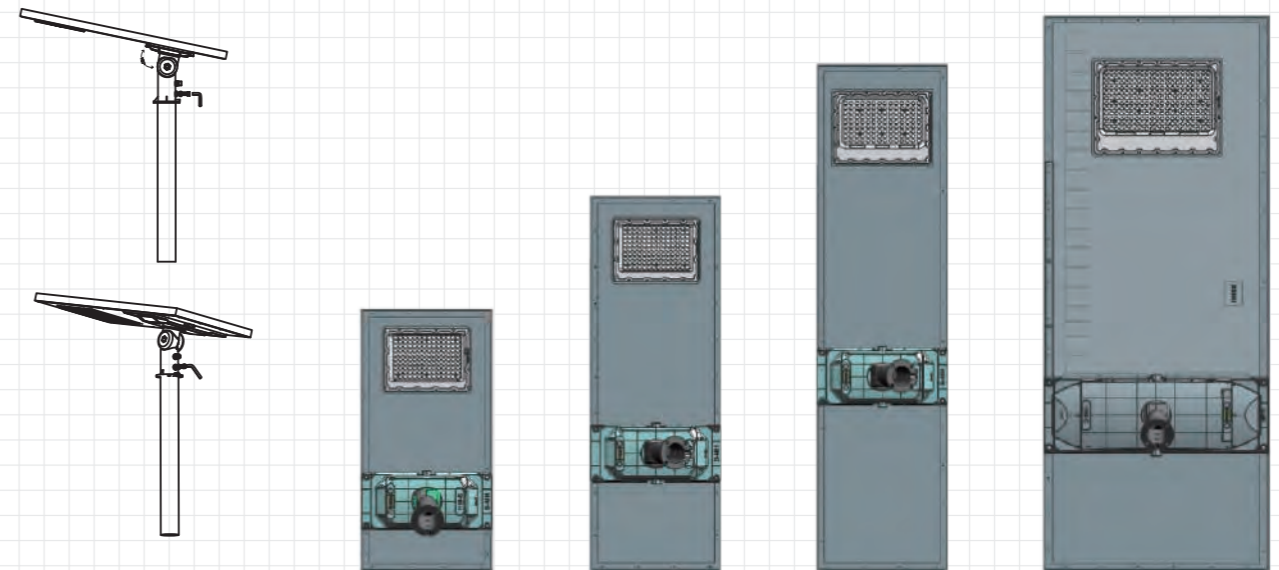



# SOLAR STREET LIGHT

## HM SERIES

B/C





### PRODUCT ADVANTAGES AND FEATURES

- Grade A+ solar cell,each cell has a complete IV curve. Conversion efficiency is more than 21.3%.
- Lithium iron phosphate battery,the discharge depth reaches 95%. Under teh discharge ratio of less than 0.5C,service life is up to 13 years, with high safety factor.
- High lumen LED SMD,with 50,000 hrs life span.
- PC outdoor optical lens,high light transmittance.
- High quality aluminum magnesium alloy,anti-corrision,substantial, durable,artistic,practical. High craft manifesting production value of famous brand.
- Designed diamond face reflection process,super high efficiency reflection light source, effectively enhance the brightness of the illumination.

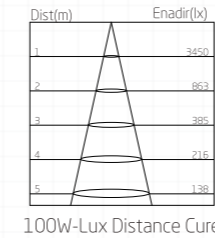
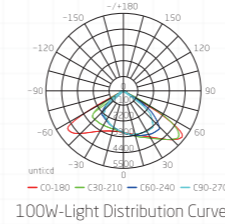

### SOLAR STREET LIGHT SERIES



#### Product Technical Parameters

Model	Luminous	Battery	Solar Panel
HM-B	170lm/W	3.2V/60Ah	5V/6V)36W
HM-C	170lm/W	3.2V/72Ah	(5V/6V)45W

**Lighting Time** The first 4 hrs full power lighting, the rest night lighting is intelligent power control; Use tuya or remote-controller switch on and off, also can adjust the brightness.

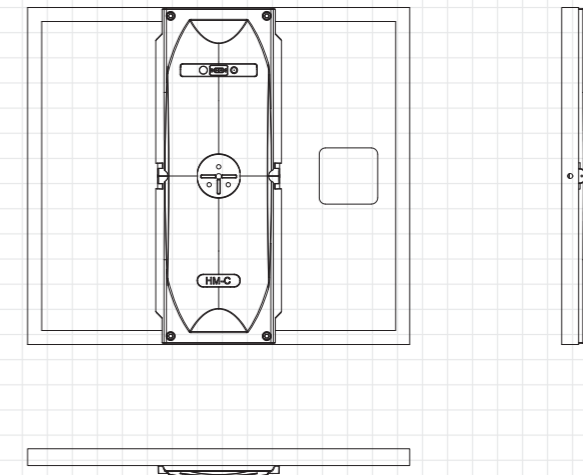

**SOLAR STREET LIGHT SERIES**

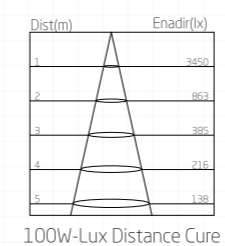
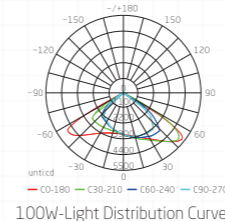

Product Technical Parameters

Model	Luminous	Battery	Solar Panel
TR06-60W	170lm/W	3.2V/15Ah	(5V/6V)22W
TR06-100W		3.2V/48Ah	(5V/6V)30W

**Lighting Time** The first 4 hrs full power lighting, the rest night lighting is intelligent power control; Use tuya or remote-controller switch on and off, also can adjust the brightness.

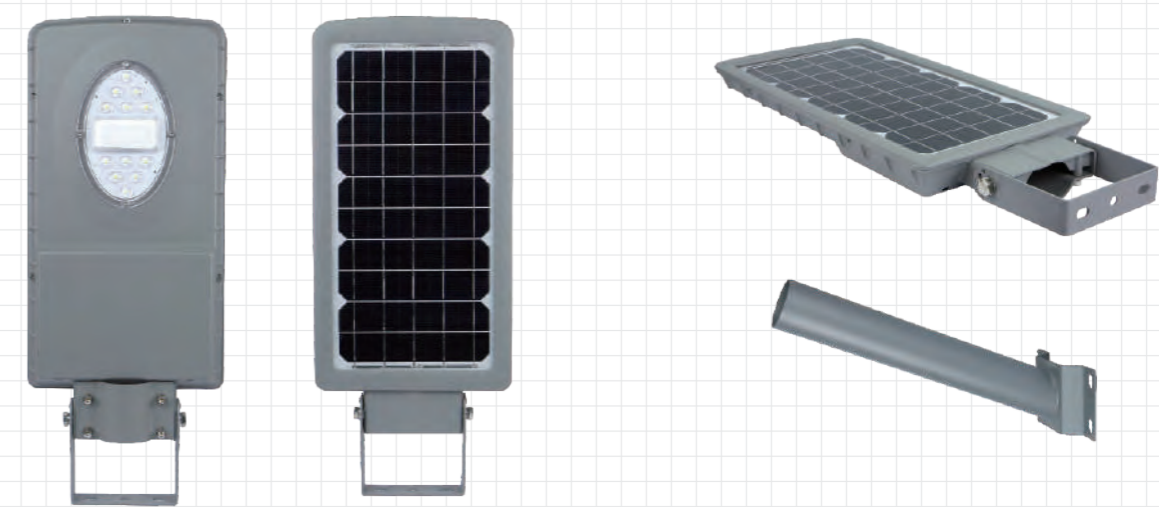

**SOLAR STREET LIGHT**

**TR06 SERIES**

60W 100W



**PRODUCT ADVANTAGES AND FEATURES**

- Grade A+ solar cell,each cell has a complete IV curve. Conversion efficiency is more than 21.3%.
- Lithium iron phosphate battery,the discharge depth reaches 95%. Under teh discharge ratio of less than 0.5C,service life is up to 13 years, with high safety factor.
- High lumen LED SMD,with 50,000 hrs life span.
- PC outdoor optical lens,high light transmittance.
- High quality aluminum magnesium alloy,anti-corrison,substantial, durable,artistic,practical.
- High craft manifesting production value of famous brand.
- Designed diamond face reflection process,super high efficiency reflection light source, effectively enhance the brightness of the illumination.





# SOLAR STREET LIGHT

## TR05 SERIES

50W 100W 150W 200W 250W



### PRODUCT ADVANTAGES AND FEATURES

- Grade A+ solar cell,each cell has a complete IV curve. Conversion efficiency is more than 21.3%.
- Lithium iron phosphate battery,the discharge depth reaches 95%. Under teh discharge ratio of less than 0.5C,service life is up to 13 years, with high safety factor.
- High lumen LED SMD,with 50,000 hrs life span.
- PC outdoor optical lens,high light transmittance.
- High quality aluminum magnesium alloy,anti-corrison,substantial, durable,artistic,practical. High craft manifesting production value of famous brand.
- Designed diamond face reflection process,super high efficiency reflection light source, effectively enhance the brightness of the illumination.



### SOLAR STREET LIGHT SERIES

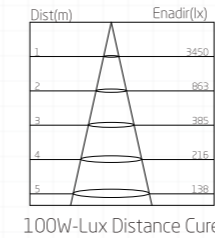
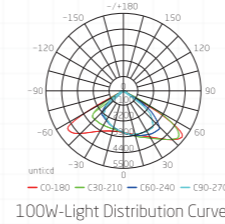

#### Product Technical Parameters

Model	Luminous	Battery	Solar Panel
TR05-50W	170lm/W	3.2V/5Ah	(5V/6V)8W
TR05-100W	170lm/W	3.2V/10Ah	(5V/6V)10W
TR05-150W	170lm/W	3.2V/15Ah	(5V/6V)23W
TR05-200W	170lm/W	3.2V/20Ah	(5V/6V)18W
TR05-250W	170lm/W	3.2V/25Ah	(5V/6V)20W

**Lighting Time** The first 4 hrs full power lighting, the rest night lighting is intelligent power control; Use tuya or remote-controller switch on and off, also can adjust the brightness.

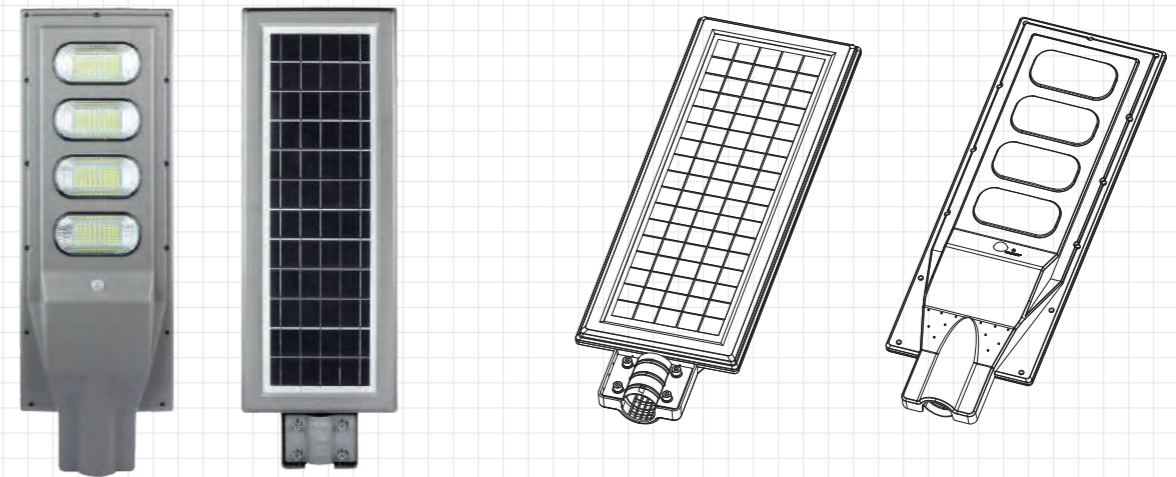

# SOLAR STREET LIGHT

## TR01-E SERIES

A

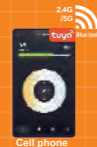



### PRODUCT ADVANTAGES AND FEATURES

- Grade A+ solar cell,each cell has a complete IV curve. Conversion efficiency is more than 21.3%.
- Lithium iron phosphate battery,the discharge depth reaches 95%. Under teh discharge ratio of less than 0.5C,service life is up to 13 years, with high safety factor.
- High lumen LED SMD,with 50,000 hrs life span.
- PC outdoor optical lens,high light transmittance.
- High quality aluminum magnesium alloy,anti-corrison,substantial, durable,artistic,practical.
- High craft manifesting production value of famous brand.
- Designed diamond face reflection process,super high efficiency reflection light source, effectively enhance the brightness of the illumination.

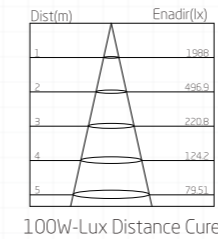
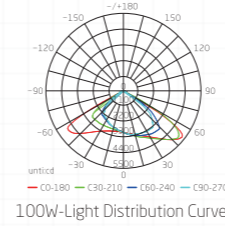

### SOLAR STREET LIGHT SERIES



#### Product Technical Parameters

Model	Luminous	Battery	Solar Panel
TR01-E	170lm/W	3.2V/25Ah	(5V/6V)30W

**Lighting Time** The first 4 hrs full power lighting, the rest night lighting is intelligent power control; Use tuya or remote-controller switch on and off, also can adjust the brightness.

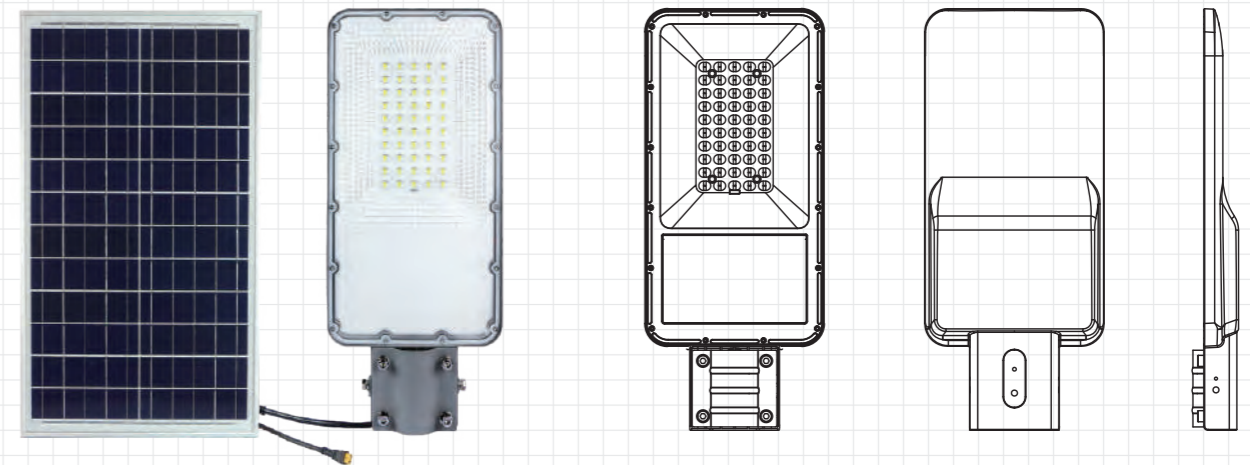



# SOLAR STREET LIGHT

## TR01 SERIES

A/B/C

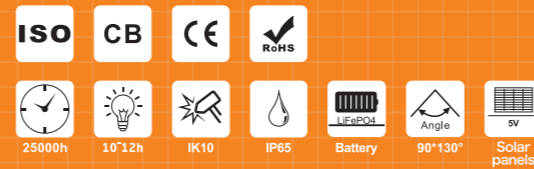

### PRODUCT ADVANTAGES AND FEATURES

- Grade A+ solar cell,each cell has a complete IV curve. Conversion efficiency is more than 21.3%.
- Lithium iron phosphate battery,the discharge depth reaches 95%. Under teh discharge ratio of less than 0.5C,service life is up to 13 years, with high safety factor.
- High lumen LED SMD,with 50,000 hrs life span.
- PC outdoor optical lens,high light transmittance.
- High quality aluminum magnesium alloy,anti-corrison,substantial, durable,artistic,practical.
- High craft manifesting production value of famous brand.
- Designed diamond face reflection process,super high efficiency reflection light source, effectively enhance the brightness of the illumination.

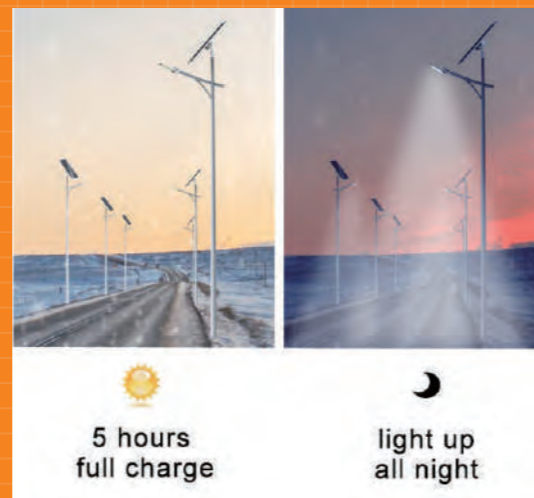

### SOLAR STREET LIGHT SERIES

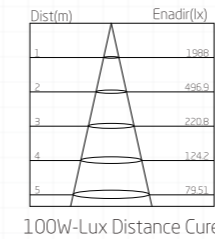
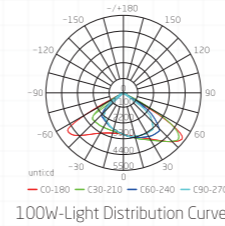

#### Product Technical Parameters

Model	Luminous	Battery	Solar Panel
TR01-A	170lm/W	3.2V/24Ah	(5V/6V)20W
TR01-B	170lm/W	3.2V/36Ah	(5V/6V)30W
TR01-C	170lm/W	3.2V/48Ah	(5V/6V)40W

**Lighting Time** The first 4 hrs full power lighting, the rest night lighting is intelligent power control; Use tuya or remote-controller switch on and off, also can adjust the brightness.

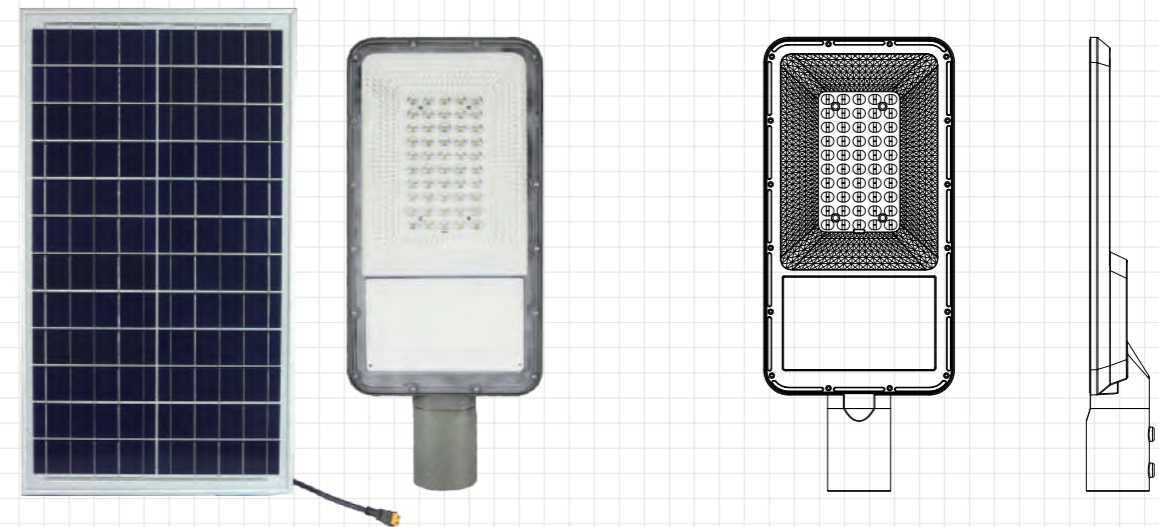



# SOLAR STREET LIGHT

## TR02 SERIES

A/B/C



### PRODUCT ADVANTAGES AND FEATURES

- Grade A+ solar cell,each cell has a complete IV curve. Conversion efficiency is more than 21.3%.
- Lithium iron phosphate battery,the discharge depth reaches 95%. Under teh discharge ratio of less than 0.5C,service life is up to 13 years, with high safety factor.
- High lumen LED SMD,with 50,000 hrs life span.
- PC outdoor optical lens,high light transmittance.
- High quality aluminum magnesium alloy,anti-corrison,substantial, durable,artistic,practical.
- High craft manifesting production value of famous brand.
- Designed diamond face reflection process,super high efficiency reflection light source, effectively enhance the brightness of the illumination.



### SOLAR STREET LIGHT SERIES

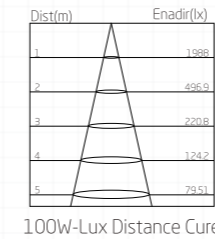
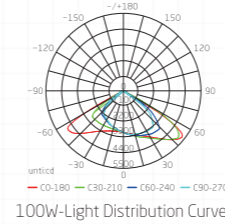

#### Product Technical Parameters

Model	Luminous	Battery	Solar Panel
TR02-A	170lm/W	3.2V/24Ah	(5V/6V)13W
TR02-B	170lm/W	3.2V/36Ah	(5V/6V)18W
TR02-C	170lm/W	3.2V/48Ah	(5V/6V)30W

**Lighting Time** The first 4 hrs full power lighting, the rest night lighting is intelligent power control; Use tuya or remote-controller switch on and off, also can adjust the brightness.

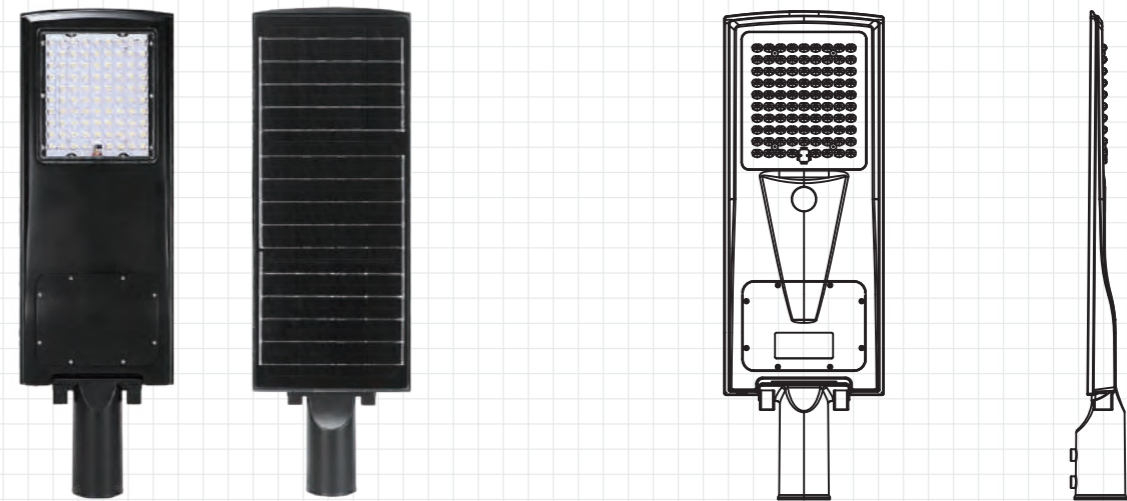



# SOLAR STREET LIGHT

## TR03 SERIES

50W 100W





### PRODUCT ADVANTAGES AND FEATURES

- Grade A+ solar cell,each cell has a complete IV curve. Conversion efficiency is more than 21.3%.
- Lithium iron phosphate battery,the discharge depth reaches 95%. Under teh discharge ratio of less than 0.5C,service life is up to 13 years, with high safety factor.
- High lumen LED SMD,with 50,000 hrs life span.
- PC outdoor optical lens,high light transmittance.
- High quality aluminum magnesium alloy,anti-corrison,substantial, durable,artistic,practical.
- High craft manifesting production value of famous brand.
- Designed diamond face reflection process,super high efficiency reflection light source, effectively enhance the brightness of the illumination.

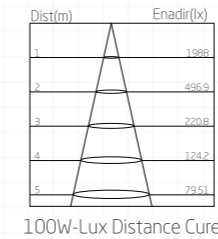
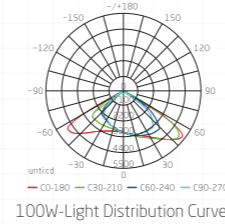

### SOLAR STREET LIGHT SERIES



#### Product Technical Parameters

Model	Luminous	Battery	Solar Panel
TR03-50W	170lm/W	3.2V/24Ah	(5V/6V)30W
TR03-100W	170lm/W	3.2V/36Ah	(5V/6V)36W

**Lighting Time** The first 4 hrs full power lighting, the rest night lighting is intelligent power control; Use tuya or remote-controller switch on and off, also can adjust the brightness.

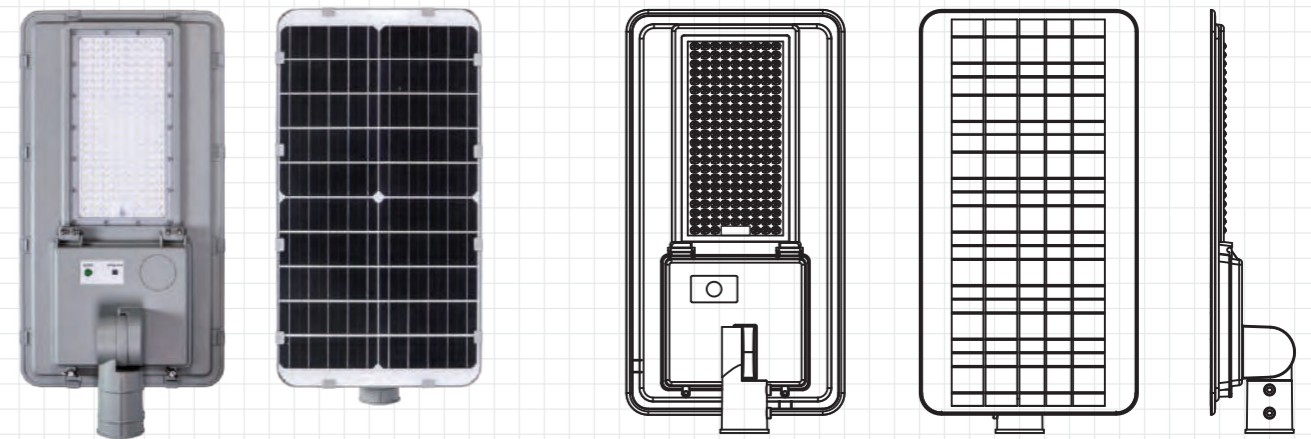



# SOLAR STREET LIGHT

## HM-RL SERIES

100W 200W 300W

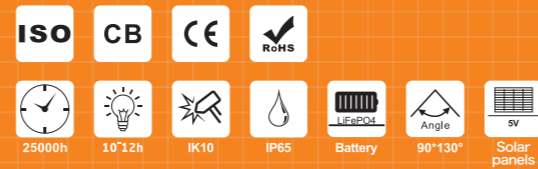

### SOLAR STREET LIGHT SERIES

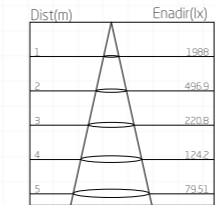
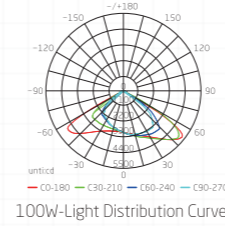

#### Product Technical Parameters

Model	Luminous	Battery	Solar Panel
HM-RL 50W	170lm/W	3.2V/25Ah	(5V/6V)30W
HM-RL 100W	170lm/W	3.2V/45Ah	(5V/6V)60W
HM-RL 200W	170lm/W	12V/40Ah	(5V/6V)100W
HM-RL 300W	170lm/W	12V/50Ah	(5V/6V)120W

**Lighting Time** The first 4 hrs full power lighting, the rest night lighting is intelligent power control; Use tuya or remote-controller switch on and off, also can adjust the brightness.

## PRODUCT ADVANTAGES AND FEATURES

- Grade A+ solar cell,each cell has a complete IV curve. Conversion efficiency is more than 21.3%.
- Lithium iron phosphate battery,the discharge depth reaches 95%. Under teh discharge ratio of less than 0.5C,service life is up to 13 years, with high safety factor.
- High lumen LED SMD,with 50,000 hrs life span.
- PC outdoor optical lens,high light transmittance.
- High quality aluminum magnesium alloy,anti-corrison,substantial, durable,artistic,practical.
- High craft manifesting production value of famous brand.
- Designed diamond face reflection process,super high efficiency reflection light source, effectively enhance the brightness of the illumination.

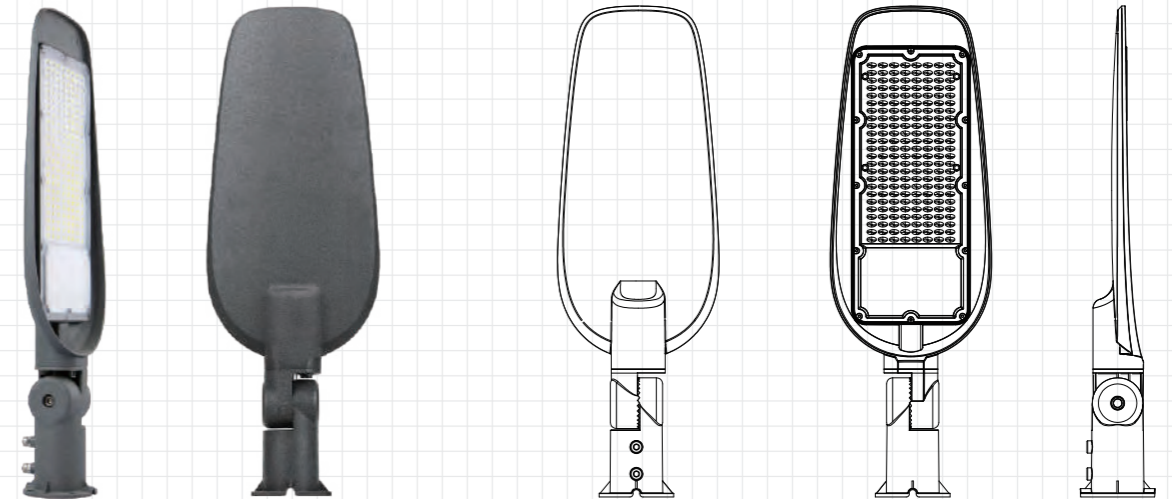



# SOLAR STREET LIGHT

## HM-RE SERIES

100W 200W 300W 500W





### PRODUCT ADVANTAGES AND FEATURES

- Grade A+ solar cell,each cell has a complete IV curve. Conversion efficiency is more than 21.3%.
- Lithium iron phosphate battery,the discharge depth reaches 95%. Under teh discharge ratio of less than 0.5C,service life is up to 13 years, with high safety factor.
- High lumen LED SMD,with 50,000 hrs life span.
- PC outdoor optical lens,high light transmittance.
- High quality aluminum magnesium alloy,anti-corrison,substantial, durable,artistic,practical.
- High craft manifesting production value of famous brand.
- Designed diamond face reflection process,super high efficiency reflection light source, effectively enhance the brightness of the illumination.

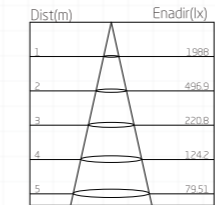
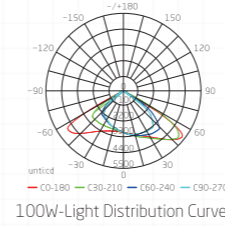

### SOLAR STREET LIGHT SERIES



#### Product Technical Parameters

Model	Luminous	Battery	Solar Panel
HM-RE 100W	170lm/W	3.2V/25Ah	(5V/6V)30W
HM-RE 200W	170lm/W	3.2V/45Ah	(5V/6V)60W
HM-RE 300W	170lm/W	12V/40Ah	(5V/6V)100W
HM-RE 500W	170lm/W	12V/50Ah	(5V/6V)120W

**Lighting Time** The first 4 hrs full power lighting, the rest night lighting is intelligent power control; Use tuya or remote-controller switch on and off, also can adjust the brightness.

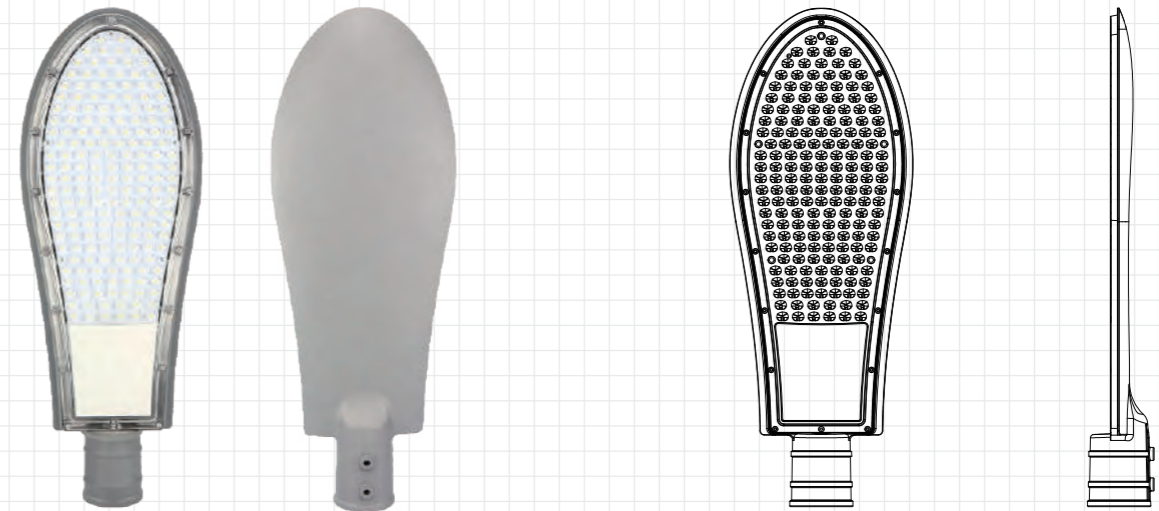



# SOLAR STREET LIGHT

## HM-RX SERIES

50W 100W



### PRODUCT ADVANTAGES AND FEATURES

- Grade A+ solar cell,each cell has a complete IV curve. Conversion efficiency is more than 21.3%.
- Lithium iron phosphate battery,the discharge depth reaches 95%. Under teh discharge ratio of less than 0.5C,service life is up to 13 years, with high safety factor.
- High lumen LED SMD,with 50,000 hrs life span.
- PC outdoor optical lens,high light transmittance.
- High quality aluminum magnesium alloy,anti-corrison,substantial, durable,artistic,practical.
- High craft manifesting production value of famous brand.
- Designed diamond face reflection process,super high efficiency reflection light source, effectively enhance the brightness of the illumination.



### SOLAR STREET LIGHT SERIES

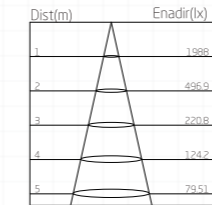
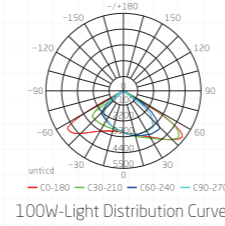

#### Product Technical Parameters

Model	Luminous	Battery	Solar Panel
HM-RX 50W	170lm/W	3.2V/25Ah	(5V/6V)30W
HM-RX 100W	170lm/W	3.2V/45Ah	(5V/6V)60W
HM-RX 150W	170lm/W	12V/40Ah	(5V/6V)100W
HM-RX 200W	170lm/W	12V/50Ah	(5V/6V)120W

**Lighting Time** The first 4 hrs full power lighting, the rest night lighting is intelligent power control; Use tuya or remote-controller switch on and off, also can adjust the brightness.

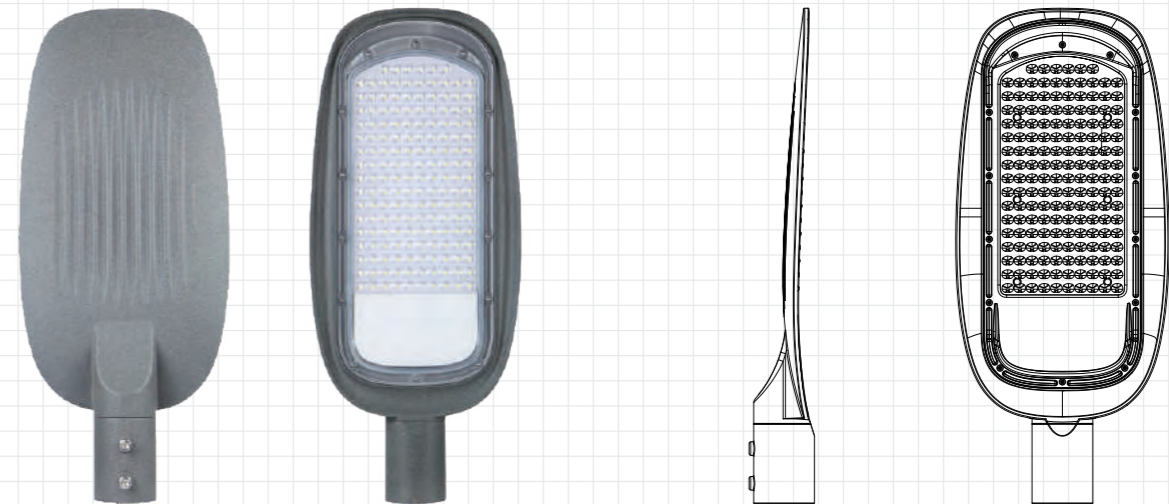



# SOLAR STREET LIGHT

## HM-RD SERIES

100W 200W 300W 500W



### SOLAR STREET LIGHT SERIES

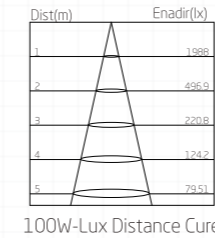
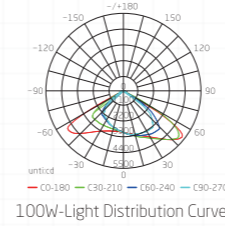

#### Product Technical Parameters

Model	Luminous	Battery	Solar Panel
HM-RD 50W	170lm/W	3.2V/25Ah	(5V/6V)30W
HM-RD 100W	170lm/W	3.2V/45Ah	(5V/6V)60W
HM-RD 150W	170lm/W	12V/40Ah	(5V/6V)100W
HM-RD 200W	170lm/W	12V/50Ah	(5V/6V)120W

**Lighting Time** The first 4 hrs full power lighting, the rest night lighting is intelligent power control; Use tuya or remote-controller switch on and off, also can adjust the brightness.

## PRODUCT ADVANTAGES AND FEATURES

- Grade A+ solar cell,each cell has a complete IV curve. Conversion efficiency is more than 21.3%.
- Lithium iron phosphate battery,the discharge depth reaches 95%. Under teh discharge ratio of less than 0.5C,service life is up to 13 years, with high safety factor.
- High lumen LED SMD,with 50,000 hrs life span.
- PC outdoor optical lens,high light transmittance.
- High quality aluminum magnesium alloy,anti-corrison,substantial, durable,artistic,practical.
- High craft manifesting production value of famous brand.
- Designed diamond face reflection process,super high efficiency reflection light source, effectively enhance the brightness of the illumination.

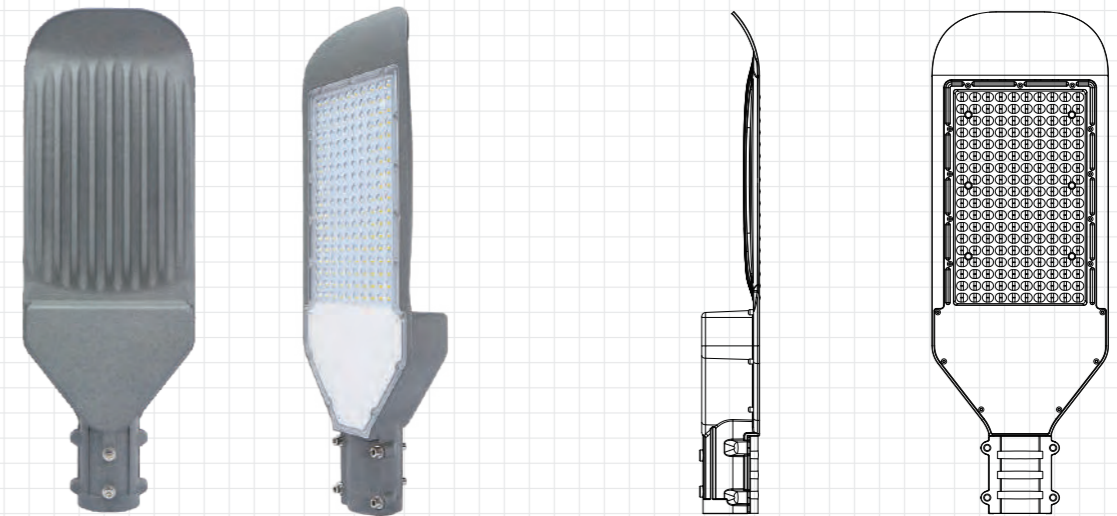

SOLAR FLOOD LIGHT SERIES



# LED SOLAR FLOOD LIGHT

## SOLAR FLOOD LIGHT SERIES

Battery		Solar Panel		Light Source
A	B	A	B	
6A	6.5A	(5V/6V)/6W	5V/10W	360lm ±8% (Same as market marks 20W)
12A	13A	(5V/6V)/12W	5V/15W	720lm ±8% (Same as market marks 40W)
24A	26A	(5V/6V)/15W	5V/22W	1400lm ±8% (Same as market marks 80W)
36A	39A	(5V/6V)/22W	5V/30W	2160lm ±8% (Same as market marks 120W)
48A	52A	(5V/6V)/30W	5V/36W	2880lm ±8% (Same as market marks 160W)
60A	65A	(5V/6V)/36W	5V/45W	3600lm ±8% (Same as market marks 200W)
72A	78A	(5V/6V)/45W	5V/65W	4320lm ±8% (Same as market marks 240W)
Lighting Time		Light control: The first 4 hrs full power lighting, the rest night lighting is intelligent power control. Remote-controller switch on and off, also can adjust the brightness.		



# SOLAR FLOOD LIGHT

## TK-E SERIES

50W 100W 200W 300W 400W 500W

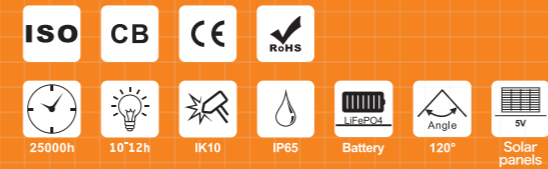

### PRODUCT ADVANTAGES AND FEATURES

- Grade A+ solar cell,each cell has a complete IV curve.Conversion efficiency is more than 21.3%.
- Lithium iron phosphate battery,the discharge depth reaches 95%. Under teh discharge ratio of less than 0.5C,service life is up to 13 years,with high safety factor.
- High lumen LED SMD,with 50,000 hrs life span.
- High intensity IK07 tempered glass,its luminous efficiency up to 95%.
- High quality aluminum magnesium alloy,anti-corrison,substantial,durable,artistic,practical.High craft manifesting production value of famous brand.
- Designed diamond face reflection process,super high efficiency reflection light source,effectively enhance the brightness of the illumination.



### SOLAR FLOOD LIGHT SERIES

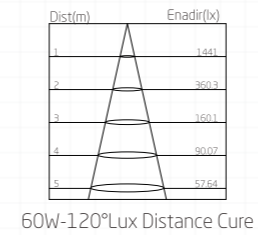
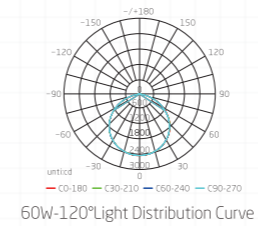

#### Product Technical Parameters

Model	Luminous	Battery	Solar Panel
TK-E 50W	170lm/W	3.2V/6Ah	(5V/6V)8W
TK-E 100W	170lm/W	3.2V/12Ah	(5V/6V)15W
TK-E 200W	170lm/W	3.2V/15Ah	(5V/6V)20W
TK-E 300W	170lm/W	3.2V/25Ah	(5V/6V)30W
TK-E 400W	170lm/W	3.2V/30Ah	(5V/6V)40W
TK-E 500W	170lm/W	3.2V/50Ah	(5V/6V)50W

**Lighting Time** The first 4 hrs full power lighting, the rest night lighting is intelligent power control; Use tuya or remote-controller switch on and off, also can adjust the brightness.

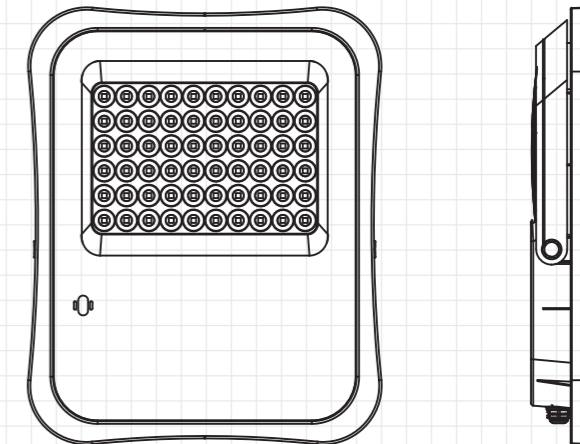

SOLAR FLOOD LIGHT SERIES

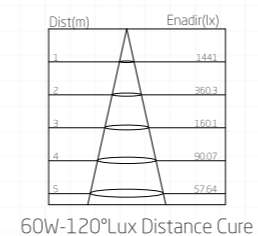
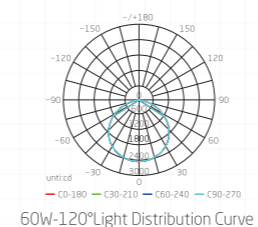

Product Technical Parameters

Model	Luminous	Battery	Solar Panel
TK05-30W	170lm/W	3.7V/5Ah	(5V/6V)8W
TK05-50W	170lm/W	3.7V/10Ah	(5V/6V)15W
TK05-100W	170lm/W	3.7V/15Ah	(5V/6V)20W
TK05-200W	170lm/W	3.7V/20Ah	(5V/6V)25W
TK05-300W	170lm/W	3.7V/30Ah	(5V/6V)30W

**Lighting Time** The first 4 hrs full power lighting, the rest night lighting is intelligent power control; Use tuya or remote-controller switch on and off, also can adjust the brightness.



SOLAR FLOOD LIGHT

TK05 SERIES

30W 50W 100W 200W 300W



PRODUCT ADVANTAGES AND FEATURES

- Grade A+ solar cell,each cell has a complete IV curve.Conversion efficiency is more than 21.3%.
- Lithium iron phosphate battery,the discharge depth reaches 95%. Under teh discharge ratio of less than 0.5C,service life is up to 13 years,with high safety factor.
- High lumen LED SMD,with 50,000 hrs life span.
- High intensity IK07 tempered glass,its luminous efficiency up to 95%.
- High quality aluminum magnesium alloy,anti-corrison,substantial,durable,artistic,practical.High craft manifesting production value of famous brand.
- Designed diamond face reflection process,super high efficiency reflection light source,effectively enhance the brightness of the illumination.

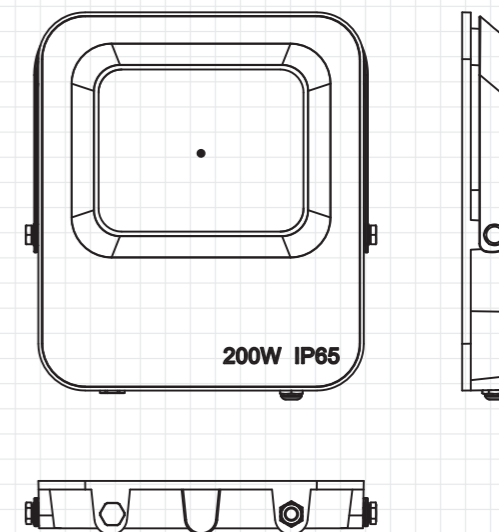
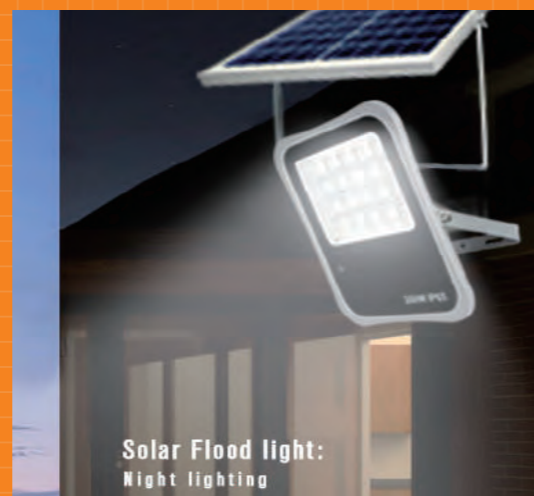



# SOLAR FLOOD LIGHT

## TK03 SERIES

-20/-60/-100/-200/-300/-500





### PRODUCT ADVANTAGES AND FEATURES

- Grade A+ solar cell,each cell has a complete IV curve.Conversion efficiency is more than 21.3%.
- Lithium iron phosphate battery,the discharge depth reaches 95%. Under teh discharge ratio of less than 0.5C,service life is up to 13 years,with high safety factor.
- High lumen LED SMD,with 50,000 hrs life span.
- High intensity IK07 tempered glass,its luminous efficiency up to 95%.
- High quality aluminum magnesium alloy,anti-corrison,substantial,durable,artistic,practical.High craft manifesting production value of famous brand.
- Designed diamond face reflection process,super high efficiency reflection light source,effectively enhance the brightness of the illumination.

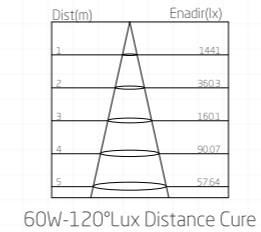
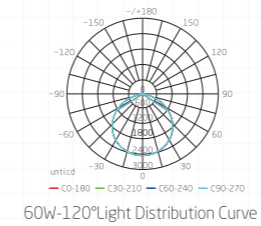

### SOLAR FLOOD LIGHT SERIES



#### Product Technical Parameters

Model	Luminous	Battery	Solar Panel
TK03-20	170lm/W	3.2V/6Ah	(5V/6V)8W
TK03-60	170lm/W	3.2V/12Ah	(5V/6V)15W
TK03-100	170lm/W	3.2V/18Ah	(5V/6V)20W
TK03-200	170lm/W	3.2V/25Ah	(5V/6V)30W
TK03-300	170lm/W	3.2V/50Ah	(5V/6V)40W
TK03-500	170lm/W	3.2V/75Ah	(5V/6V)60W

**Lighting Time** The first 4 hrs full power lighting, the rest night lighting is intelligent power control; Use tuya or remote-controller switch on and off, also can adjust the brightness.

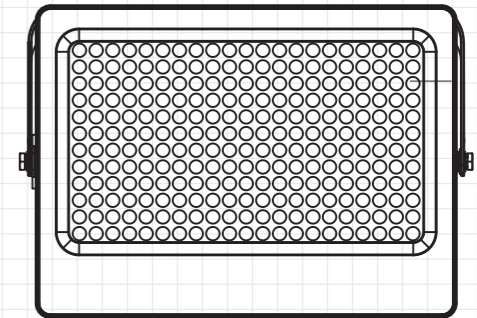
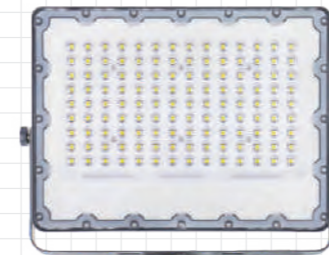

# SOLAR FLOOD LIGHT

## TK02 SERIES

A/B/C/D/E

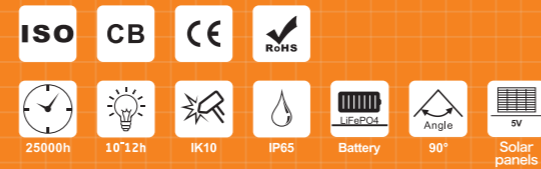

### PRODUCT ADVANTAGES AND FEATURES

- Grade A+ solar cell,each cell has a complete IV curve.Conversion efficiency is more than 21.3%.
- Lithium iron phosphate battery,the discharge depth reaches 95%. Under teh discharge ratio of less than 0.5C,service life is up to 13 years,with high safety factor.
- High lumen LED SMD,with 50,000 hrs life span.
- High intensity IK07 tempered glass,its luminous efficiency up to 95%.
- High quality aluminum magnesium alloy,anti-corrison,substantial,durable,artistic,practical.High craft manifesting production value of famous brand.
- Designed diamond face reflection process,super high efficiency reflection light source,effectively enhance the brightness of the illumination.



### SOLAR FLOOD LIGHT SERIES

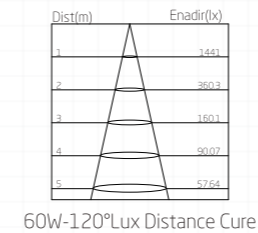
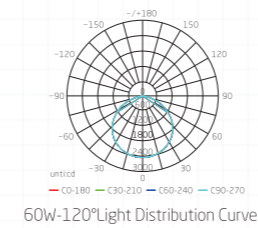

#### Product Technical Parameters

Model	Luminous	Battery	Solar Panel
TK02-A	170lm/W	3.2V/6Ah	(5V/6V)8W
TK02-B	170lm/W	3.2V/12Ah	(5V/6V)15W
TK02-C	170lm/W	3.2V/24Ah	(5V/6V)25W
TK02-D	170lm/W	3.2V/36Ah	(5V/6V)35W
TK02-E	170lm/W	3.2V/60Ah	(5V/6V)60W

**Lighting Time** The first 4 hrs full power lighting, the rest night lighting is intelligent power control; Use tuya or remote-controller switch on and off, also can adjust the brightness.

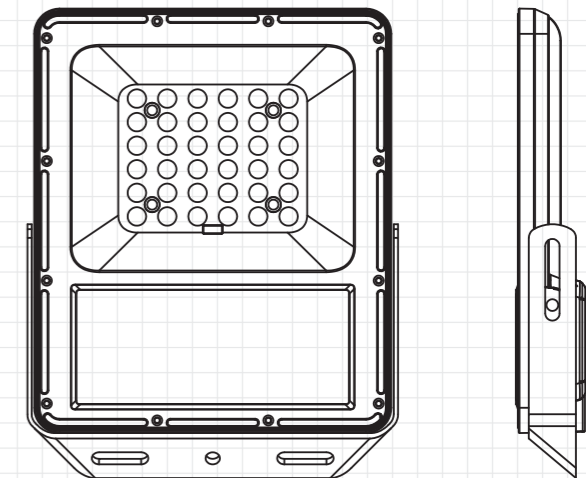

# SOLAR FLOOD LIGHT

## TK01 SERIES

30W 60W 100W 150W 200W



### PRODUCT ADVANTAGES AND FEATURES

- Grade A+ solar cell,each cell has a complete IV curve.Conversion efficiency is more than 21.3%.
- Lithium iron phosphate battery,the discharge depth reaches 95%. Under teh discharge ratio of less than 0.5C,service life is up to 13 years,with high safety factor.
- High lumen LED SMD,with 50,000 hrs life span.
- High intensity IK07 tempered glass,its luminous efficiency up to 95%.
- High quality aluminum magnesium alloy,anti-corrison,substantial, durable,artistic,practical.High craft manifesting production value of famous brand.
- Designed diamond face reflection process,super high efficiency reflection light source,effectively enhance the brightness of the illumination.



### SOLAR FLOOD LIGHT SERIES

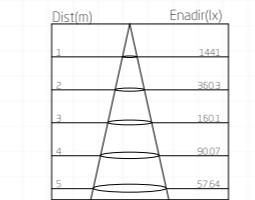
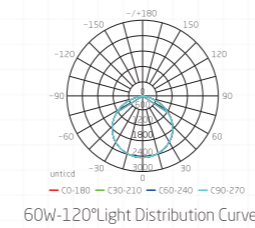

#### Product Technical Parameters

Model	Luminous	Battery	Solar Panel
TK01-30W	170lm/W	3.2V/5Ah	(5V/6V)6W
TK01-60W	170lm/W	3.2V/12Ah	(5V/6V)15W
TK01-100W	170lm/W	3.2V/24Ah	(5V/6V)25W
TK01-150W	170lm/W	3.2V/36Ah	(5V/6V)35W
TK01-200W	170lm/W	3.2V/42Ah	(5V/6V)50W

**Lighting Time** The first 4 hrs full power lighting, the rest night lighting is intelligent power control; Use tuya or remote-controller switch on and off, also can adjust the brightness.

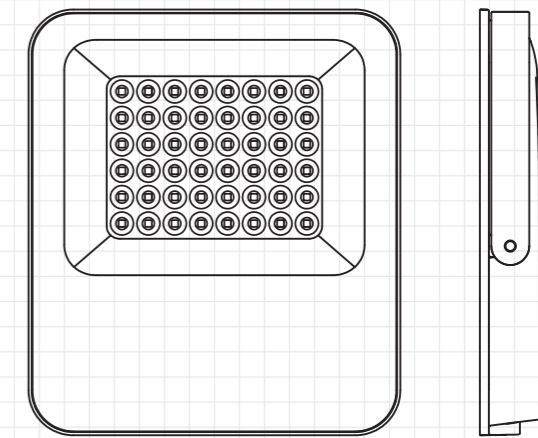



# SOLAR FLOOD LIGHT

## T-IK02 SERIES

30W 50W 100W 150W 200W

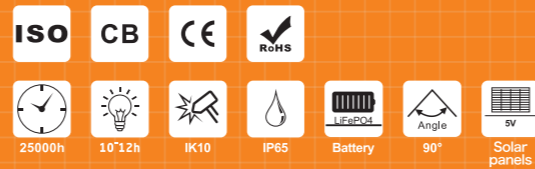

### PRODUCT ADVANTAGES AND FEATURES

- Grade A+ solar cell,each cell has a complete IV curve.Conversion efficiency is more than 21.3%.
- Lithium iron phosphate battery,the discharge depth reaches 95%. Under teh discharge ratio of less than 0.5C,service life is up to 13 years,with high safety factor.
- High lumen LED SMD,with 50,000 hrs life span.
- High intensity IK07 tempered glass,its luminous efficiency up to 95%.
- High quality aluminum magnesium alloy,anti-corrion,substantial,durable,artistic,practical.High craft manifesting production value of famous brand.
- Designed diamond face reflection process,super high efficiency reflection light source,effectively enhance the brightness of the illumination.



### SOLAR FLOOD LIGHT SERIES

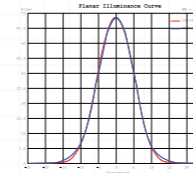
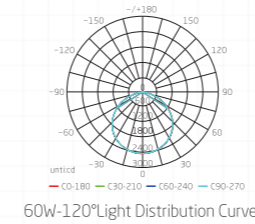

#### Product Technical Parameters

Model	Luminous	Battery	Solar Panel
T-IK02 30W	170lm/W	3.7V/5Ah	(5V/6V)8W
T-IK02 50W	170lm/W	3.7V/10Ah	(5V/6V)15W
T-IK02 100W	170lm/W	3.7V/15Ah	(5V/6V)20W
T-IK02 150W	170lm/W	3.7V/20Ah	(5V/6V)25W
T-IK02 200W	170lm/W	3.7V/30Ah	(5V/6V)30W

**Lighting Time** The first 4 hrs full power lighting, the rest night lighting is intelligent power control; Use tuya or remote-controller switch on and off, also can adjust the brightness.

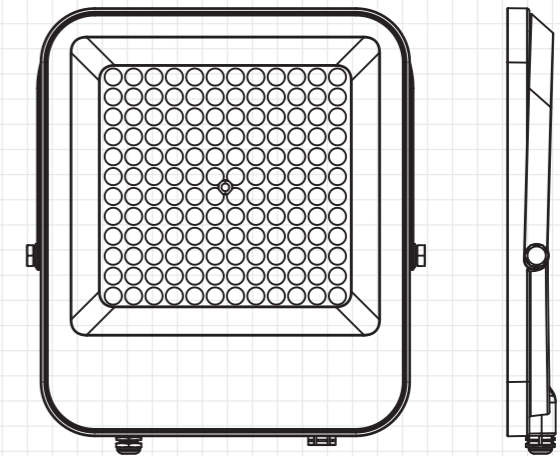

WORK LIGHT SERIES



# WORK LIGHT

## TG01 SERIES

30W 50W 100W



## PRODUCT ADVANTAGES AND FEATURES

- Grade A+ solar cell,each cell has a complete IV curve. Conversion efficiency is more than 21.3%.
- Lithium iron phosphate battery,the discharge depth reaches 95%. Under teh discharge ratio of less than 0.5C,service life is up to 13 years, with high safety factor.
- High lumen LED SMD,with 50,000 hrs life span.
- PC outdoor optical lens,high light transmittance.
- High quality aluminum magnesium alloy,anti-corrison,substantial, durable,artistic,practical.
- High craft manifesting production value of famous brand.
- Designed diamond face reflection process,super high efficiency reflection light source,effectively enhance the brightness of the illumination.



## WORK LIGHT SERIES

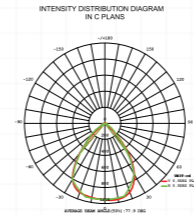

100W-Light Distribution Curve

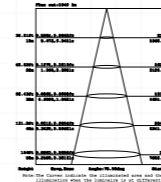

100W-Lux Distance Curve

### Product Technical Parameters

Model	Luminous	Battery	Mode
TG01-30W	200lm/W	3.7V/5Ah	1)100% power;
TG01-50W	200lm/W	3.7V/10Ah	2)60% power;
TG01-100W	200lm/W	3.7V/15Ah	3)20% power;
			4)Emergency light

**Lighting Time** Auto Working Mode: Fully charged, can work for 10 hours

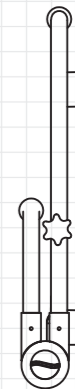
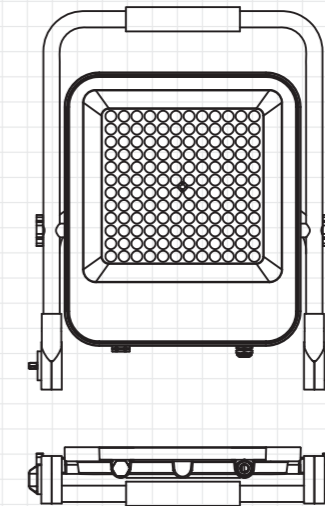



# WORK LIGHT

## TG02 SERIES

30W 50W 100W



### PRODUCT ADVANTAGES AND FEATURES

- Grade A+ solar cell,each cell has a complete IV curve. Conversion efficiency is more than 21.3%.
- Lithium iron phosphate battery,the discharge depth reaches 95%. Under teh discharge ratio of less than 0.5C,service life is up to 13 years, with high safety factor.
- High lumen LED SMD,with 50,000 hrs life span.
- PC outdoor optical lens,high light transmittance.
- High quality aluminum magnesium alloy,anti-corrison,substantial, durable,artistic,practical.
- High craft manifesting production value of famous brand.
- Designed diamond face reflection process,super high efficiency reflection light source,effectively enhance the brightness of the illumination.



### WORK LIGHT SERIES

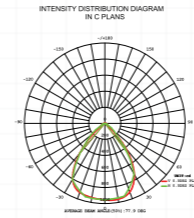

100W-Light Distribution Curve

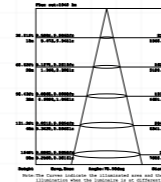

100W-Lux Distance Curve

#### Product Technical Parameters

Model	Luminous	Battery	Mode
TG02-30W	200lm/W	3.2V/5Ah	1)100% power;
TG02-50W	200lm/W	3.2V/10Ah	2)60% power;
TG02-100W	200lm/W	3.2V/20Ah	3)20% power;
			4)Emergency light

**Lighting Time** Auto Working Mode: Fully charged, can work for 10 hours

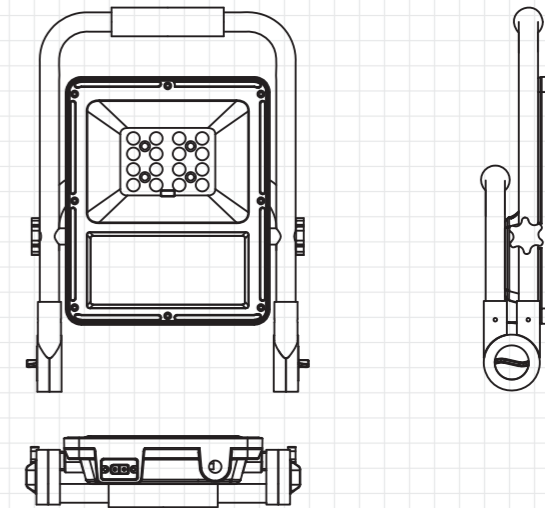



# WORK LIGHT

## TG03 SERIES

30W 50W 100W





### PRODUCT ADVANTAGES AND FEATURES

- Grade A+ solar cell,each cell has a complete IV curve. Conversion efficiency is more than 21.3%.
- Lithium iron phosphate battery,the discharge depth reaches 95%. Under teh discharge ratio of less than 0.5C,service life is up to 13 years, with high safety factor.
- High lumen LED SMD,with 50,000 hrs life span.
- PC outdoor optical lens,high light transmittance.
- High quality aluminum magnesium alloy,anti-corrison,substantial, durable,artistic,practical.
- High craft manifesting production value of famous brand.
- Designed diamond face reflection process,super high efficiency reflection light source,effectively enhance the brightness of the illumination.

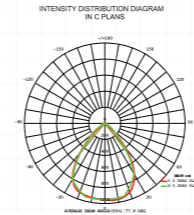

### WORK LIGHT SERIES



100W-Light Distribution Curve

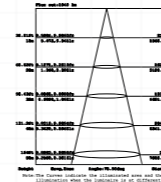

100W-Lux Distance Curve

#### Product Technical Parameters

Model	Luminous	Battery	Mode
TG03-30W	200lm/W	3.2V/15Ah	1)100% power;
TG03-50W	200lm/W	3.2V/25Ah	2)60% power;
TG03-100W	200lm/W	3.2V/50Ah	3)20% power;
			4)Emergency light

**Lighting Time** Auto Working Mode: Fully charged, can work for 10 hours

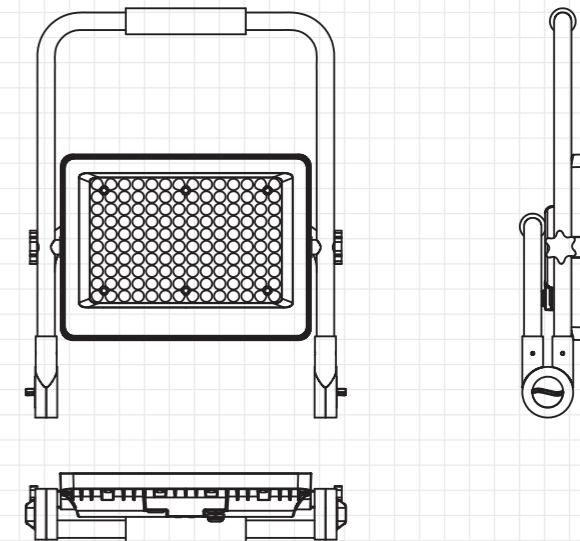

**STREET LIGHT SERIES**

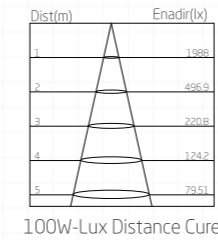
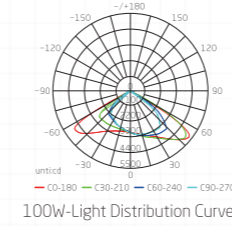

Product Technical Parameters

Model	Luminous	Power factor	SPD
RL-30W	100-120lm/W	>0.9	>6KV
RL-50W	100-120lm/W	>0.9	>6KV
RL-100W	100-120lm/W	>0.9	>8KV
RL-150W	100-120lm/W	>0.9	>10KV
RL-200W	100-120lm/W	>0.9	>10KV

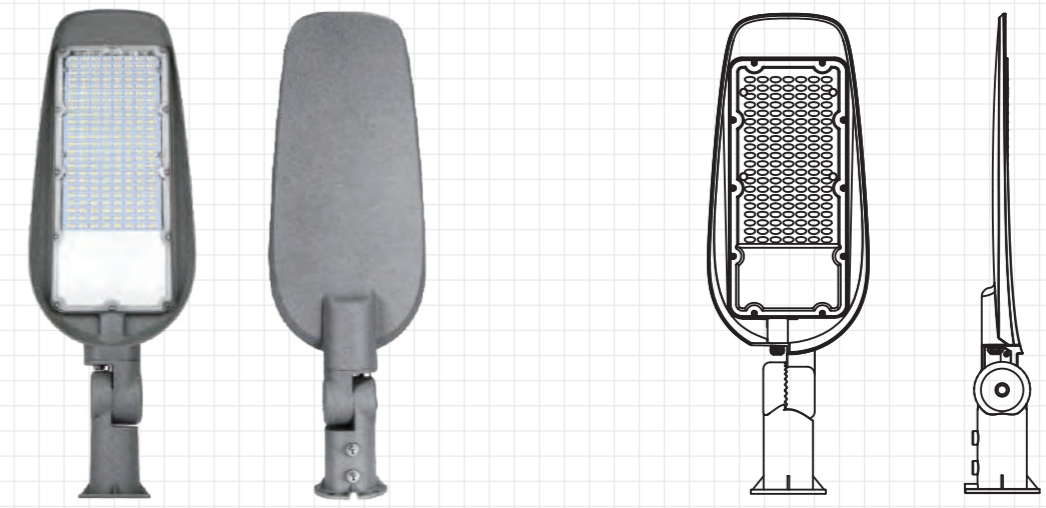

**STREET LIGHT**

**RL** SERIES

30W 50W 100W 150W 200W



**PRODUCT ADVANTAGES AND FEATURES**

- Integrated cooling design, compact, elegant, efficient.
- Streamline design, more beautiful appearance, no accumulation.
- ADC12# die-cast aluminum body, excellent heat performance, more durable.
- Professional outdoor painting, stainless steel components, giving excellent performance in anti-corrosion and anti-rusting, widely used in different environment.
- Light transmittance up to 94%, easy to improve in the future.



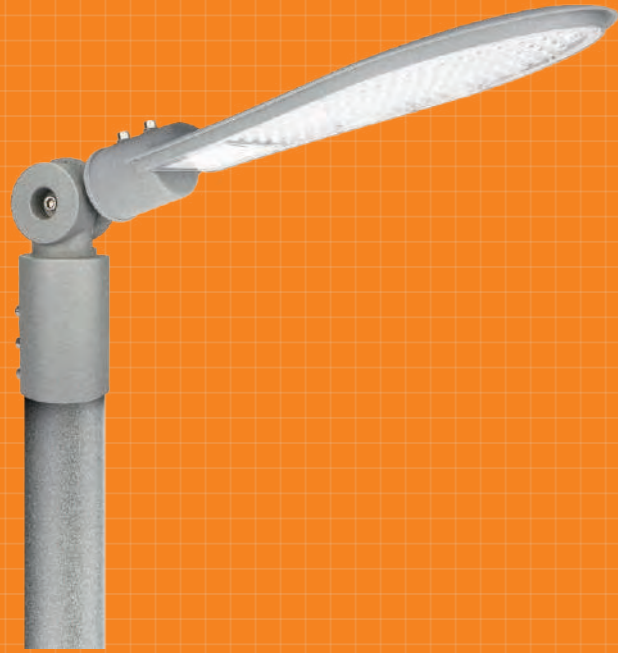

# STREET LIGHT

## RE SERIES

30W 50W 100W 150W 200W



## STREET LIGHT SERIES

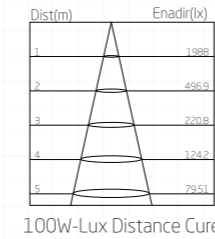
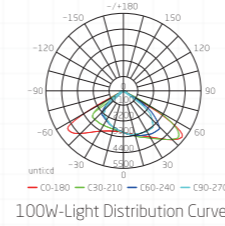

### Product Technical Parameters

Model	Luminous	Power factor	SPD
RE-30W	100lm/W	>0.9	>6KV
RE-50W	100lm/W	>0.9	>6KV
RE-100W	100lm/W	>0.9	>8KV
RE-150W	100lm/W	>0.9	>10KV
RE-200W	100lm/W	>0.9	>10KV

## PRODUCT ADVANTAGES AND FEATURES

- Integrated cooling design, compact, elegant, efficient.
- Streamline design, more beautiful appearance, no accumulation.
- ADC12# die-cast aluminum body, excellent heat performance, more durable.
- Professional outdoor painting, stainless steel components, giving excellent performance in anti-corrosion and anti-rusting, widely used in different environment.
- Light transmittance up to 94%, easy to improve in the future.

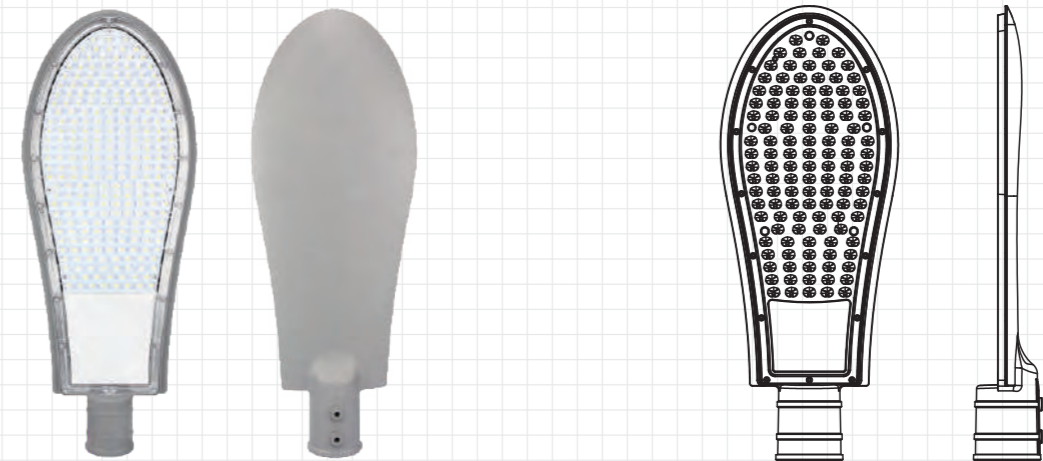

# STREET LIGHT

## RX SERIES

50W 100W 150W 200W



### PRODUCT ADVANTAGES AND FEATURES

- Integrated cooling design, compact, elegant, efficient.
- Streamline design, more beautiful appearance, no accumulation.
- ADC12# die-cast aluminum body, excellent heat performance, more durable.
- Professional outdoor painting, stainless steel components, giving excellent performance in anti-corrosion and anti-rusting, widely used in different environment.
- Light transmittance up to 94%, easy to improve in the future.



### STREET LIGHT SERIES

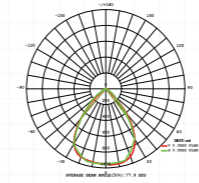

100W-Light Distribution Curve

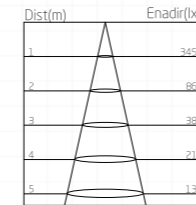

100W-Lux Distance Curve

#### Product Technical Parameters

Model	Luminous	Power factor	SPD
RX-50W	100-120lm/W	>0.9	>6KV
RX-100W	100-120lm/W	>0.9	>8KV
RX-150W	100-120lm/W	>0.9	>10KV
RX-200W	100-120lm/W	>0.9	>10KV

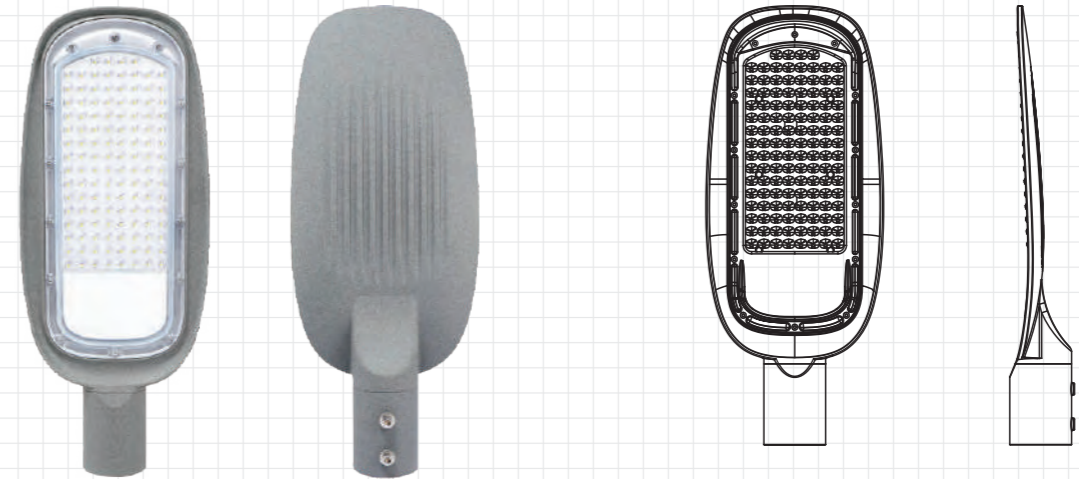

## STREET LIGHT SERIES

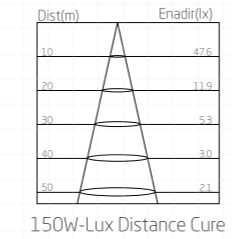
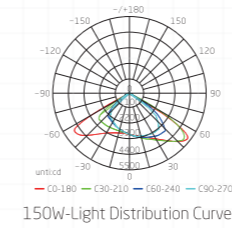

### Product Technical Parameters

Model	Luminous	Power factor	SPD
RD-30W	130-150lm/W	>0.9	>6KV
RD-50W	130-150lm/W	>0.9	>6KV
RD-100W	130-150lm/W	>0.9	>8KV
RD-150W	130-150lm/W	>0.9	>10KV
RD-200W	130-150lm/W	>0.9	>10KV

# STREET LIGHT

## RD SERIES

30W 50W 100W 150W 200W



## PRODUCT ADVANTAGES AND FEATURES

- Integrated cooling design, compact, elegant, efficient.
- Streamline design, more beautiful appearance, no accumulation.
- ADC12# die-cast aluminum body, excellent heat performance, more durable.
- Professional outdoor painting, stainless steel components, giving excellent performance in anti-corrosion and anti-rusting, widely used in different environment.
- Light transmittance up to 94%, easy to improve in the future.

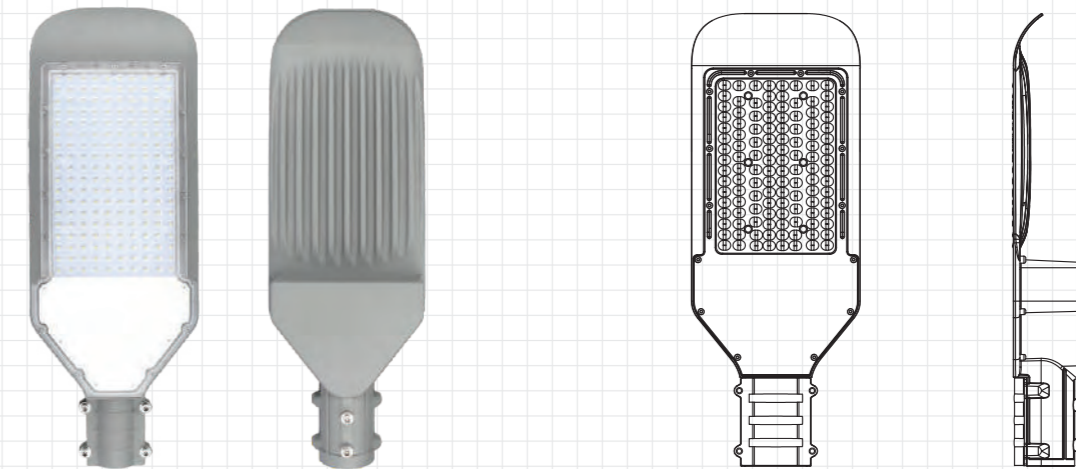

# FLOOD LIGHT

## IK03 SERIES

20W 30W 50W 100W  
150W 200W



### PRODUCT ADVANTAGES AND FEATURES

- Integrated cooling design, elegant, efficient.
- Streamline design, more beautiful appearance, no accumulation.
- ADC12# die-cast aluminum body, excellent heat performance, more durable.
- Professional outdoor painting, stainless steel components, giving excellent performance in anti-corrosion and anti-rusting, widely used in different environment.
- Light transmittance up to 94%, easy to improve in the future.



### FLOOD LIGHT SERIES

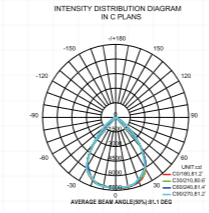

100W-Light Distribution Curve

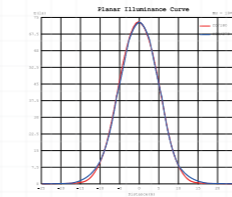

100W-Lux Distance Curve

#### Product Technical Parameters

Model	Luminous	Power factor	SPD
IK03-20W	100-110lm/W	>0.9	>2KV
IK03-30W	100-110lm/W	>0.9	>2KV
IK03-50W	100-110lm/W	>0.9	>2KV
IK03-100W	100-110lm/W	>0.9	>6KV
IK03-150W	100-110lm/W	>0.9	>8KV
IK03-200W	100-110lm/W	>0.9	>8KV

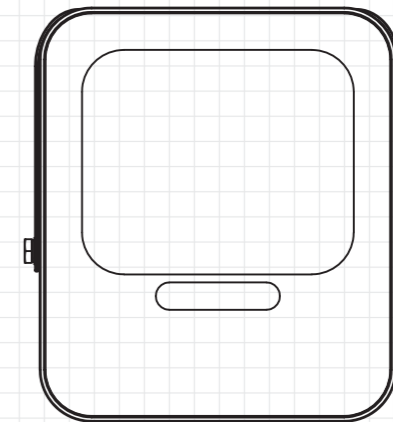

# FLOOD LIGHT

## IK01 SERIES

20W 30W 50W 100W  
150W 200W



### PRODUCT ADVANTAGES AND FEATURES

- Integrated cooling design, elegant, efficient.
- Streamline design, more beautiful appearance, no accumulation.
- ADC12# die-cast aluminum body, excellent heat performance, more durable.
- Professional outdoor painting, stainless steel components, giving excellent performance in anti-corrosion and anti-rusting, widely used in different environment.
- Light transmittance up to 94%, easy to improve in the future.



### FLOOD LIGHT SERIES

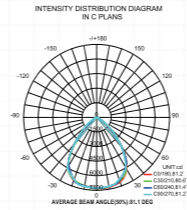

100W-Light Distribution Curve

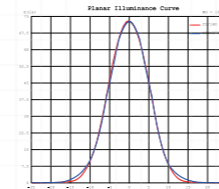

100W-Lux Distance Curve

#### Product Technical Parameters

Model	Luminous	Power factor	SPD
IK01-20W	90-120lm/W	>0.9	>2KV
IK01-30W	90-120lm/W	>0.9	>2KV
IK01-50W	90-120lm/W	>0.9	>6KV
IK01-100W	90-120lm/W	>0.9	>8KV
IK01-150W	90-120lm/W	>0.9	>10KV
IK01-200W	90-120lm/W	>0.9	>10KV

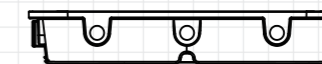
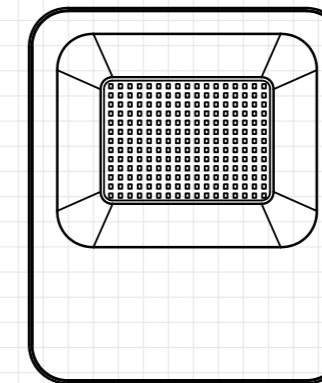

# FLOOD LIGHT

## IK02 SERIES

30W 50W 100W 150W 200W



### PRODUCT ADVANTAGES AND FEATURES

- Integrated cooling design, elegant, efficient.
- Streamline design, more beautiful appearance, no accumulation.
- ADC12# die-cast aluminum body, excellent heat performance, more durable.
- Professional outdoor painting, stainless steel components, giving excellent performance in anti-corrosion and anti-rusting, widely used in different environment.
- Light transmittance up to 94%, easy to improve in the future.



### FLOOD LIGHT SERIES

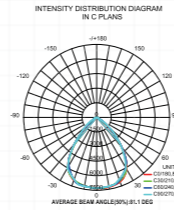

100W-Light Distribution Curve

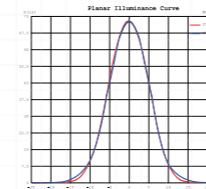

100W-Lux Distance Curve

#### Product Technical Parameters

Model	Luminous	Power factor	SPD
IK02-30W	130-140lm/W	>0.9	>2KV
IK02-50W	130-140lm/W	>0.9	>3KV
IK02-100W	130-140lm/W	>0.9	>6KV
IK02-150W	130-140lm/W	>0.9	>8KV
IK02-200W	130-140lm/W	>0.9	>8KV

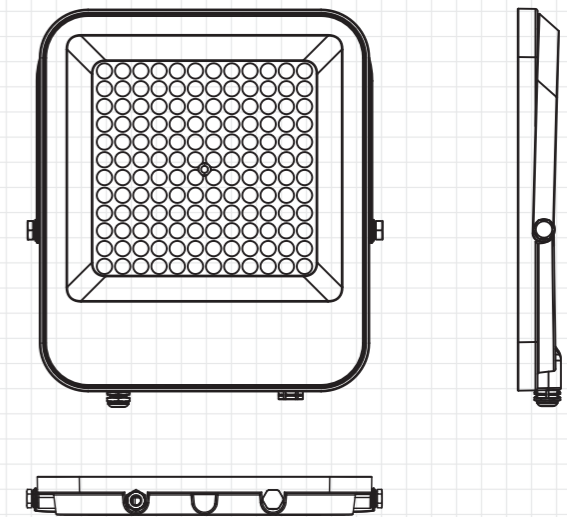

# FLOOD LIGHT

## BK02 SERIES

10W 20W 30W 50W 100W  
150W 200W



### PRODUCT ADVANTAGES AND FEATURES

- Integrated cooling design, elegant, efficient.
- Streamline design, more beautiful appearance, no accumulation.
- ADC12# die-cast aluminum body, excellent heat performance, more durable.
- Professional outdoor painting, stainless steel components, giving excellent performance in anti-corrosion and anti-rusting, widely used in different environment.
- Light transmittance up to 94%, easy to improve in the future.



### FLOOD LIGHT SERIES

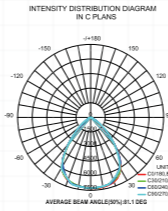

100W-Light Distribution Curve

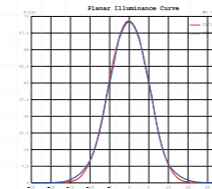

100W-Lux Distance Curve

#### Product Technical Parameters

Model	Luminous	Power factor	SPD
BK02-10W	100-110lm/W	>0.9	>2KV
BK02-20W	100-110lm/W	>0.9	>2KV
BK02-30W	100-110lm/W	>0.9	>2KV
BK02-50W	100-110lm/W	>0.9	>3KV
BK02-100W	100-110lm/W	>0.9	>5KV
BK02-150W	100-110lm/W	>0.9	>8KV
BK02-200W	100-110lm/W	>0.9	>8KV

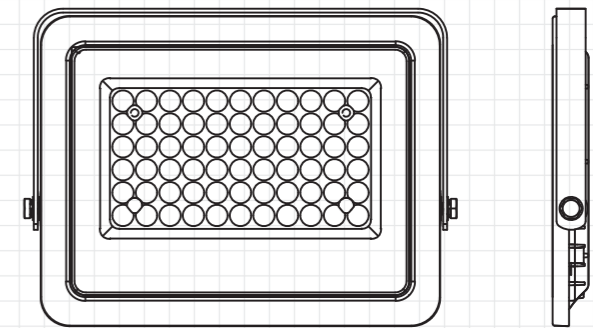
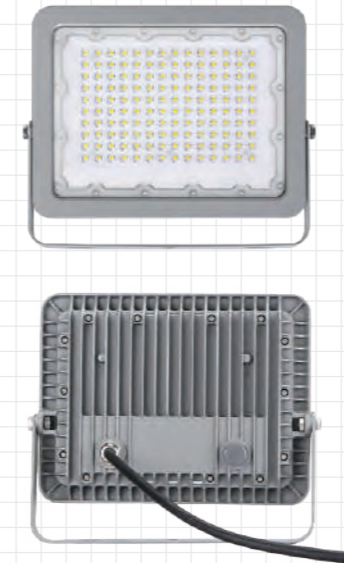



## FLOOD LIGHT

### EK SERIES

10W 20W 30W 50W 100W  
150W 200W



## PRODUCT ADVANTAGES AND FEATURES

- Integrated cooling design, elegant, efficient.
- Streamline design, more beautiful appearance, no accumulation.
- ADC12# die-cast aluminum body, excellent heat performance, more durable.
- Professional outdoor painting, stainless steel components, giving excellent performance in anti-corrosion and anti-rusting, widely used in different environment.
- Light transmittance up to 94%, easy to improve in the future.



## FLOOD LIGHT SERIES

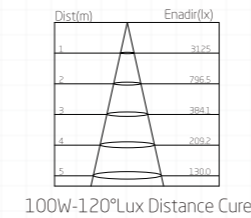
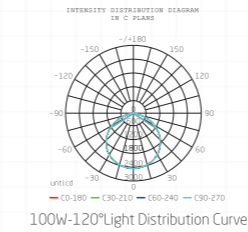

### Product Technical Parameters

Model	Luminous	Power factor	SPD
EK-10W	80-90lm/W	>0.9	>2KV
EK-20W	80-90lm/W	>0.9	>2KV
EK-30W	80-90lm/W	>0.9	>2KV
EK-50W	80-90lm/W	>0.9	>3KV
EK-100W	80-90lm/W	>0.9	>6KV
EK-150W	80-90lm/W	>0.9	>8KV
EK-200W	80-90lm/W	>0.9	>8KV

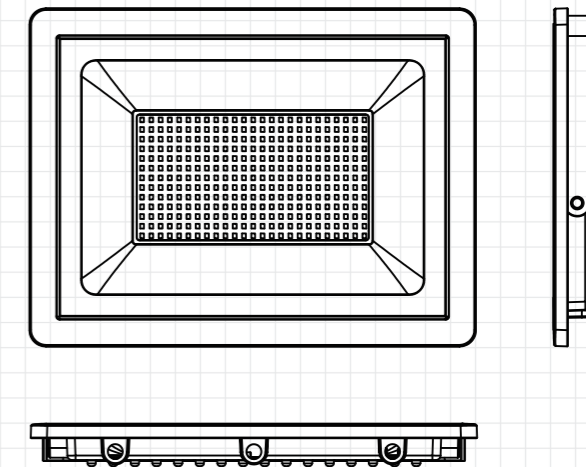

# FLOOD LIGHT

## BK SERIES

10W 20W 30W 50W 100W  
120W 150W 200W 300W



# FLOOD LIGHT SERIES

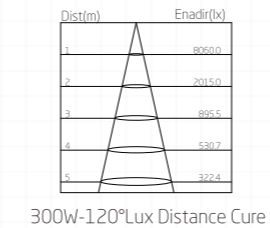
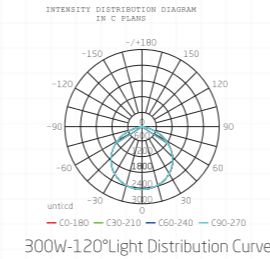

### Product Technical Parameters

Model	Luminous	Power factor	SPD
BK-10W	80-90lm/W	>0.9	>2KV
BK-20W	80-90lm/W	>0.9	>2KV
BK-30W	80-90lm/W	>0.9	>2KV
BK-50W	80-90lm/W	>0.9	>3KV
BK-100W	80-90lm/W	>0.9	>6KV
BK-120W	80-90lm/W	>0.9	>8KV
BK-150W	80-90lm/W	>0.9	>8KV
BK-200W	80-90lm/W	>0.9	>8KV
BK-300W	80-90lm/W	>0.9	>10KV

## PRODUCT ADVANTAGES AND FEATURES

- Integrated cooling design, elegant, efficient.
- Streamline design, more beautiful appearance, no accumulation.
- ADC12# die-cast aluminum body, excellent heat performance, more durable.
- Professional outdoor painting, stainless steel components, giving excellent performance in anti-corrosion and anti-rusting, widely used in different environment.
- Light transmittance up to 94%, easy to improve in the future.

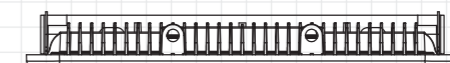
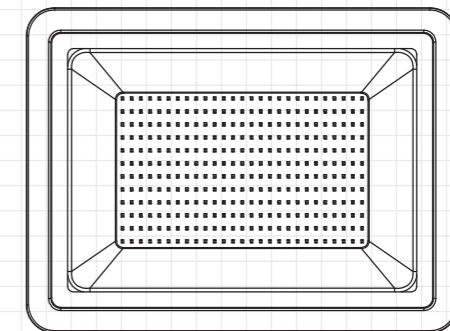

# FLOOD LIGHT

## AK SERIES

20W 30W 50W 70W 100W  
150W 200W



# FLOOD LIGHT SERIES

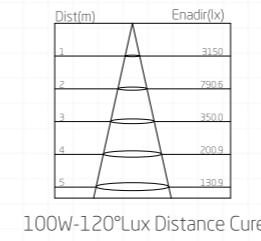
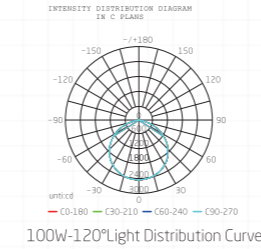

### Product Technical Parameters

Model	Luminous	Power factor	SPD
AK-20W	90lm/W	>0.9	>2KV
AK-30W	90lm/W	>0.9	>2KV
AK-50W	90lm/W	>0.9	>3KV
AK-70W	90lm/W	>0.9	>3KV
AK-100W	90lm/W	>0.9	>6KV
AK-150W	90lm/W	>0.9	>8KV
AK-200W	90lm/W	>0.9	>8KV

## PRODUCT ADVANTAGES AND FEATURES

- Integrated cooling design, elegant, efficient.
- Streamline design, more beautiful appearance, no accumulation.
- ADC12# die-cast aluminum body, excellent heat performance, more durable.
- Professional outdoor painting, stainless steel components, giving excellent performance in anti-corrosion and anti-rusting, widely used in different environment.
- Light transmittance up to 94%, easy to improve in the future.

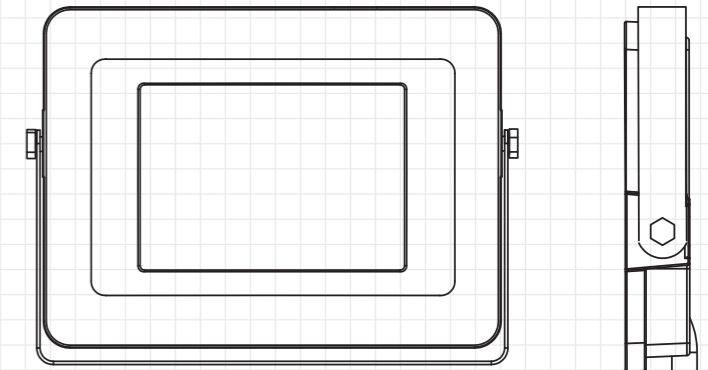



## FLOOD LIGHT

### LV-UGR SERIES

10W 20W 30W 50W 100W  
150W 200W



## PRODUCT ADVANTAGES AND FEATURES

- Integrated cooling design, elegant, efficient.
- Streamline design, more beautiful appearance, no accumulation.
- ADC12# die-cast aluminum body, excellent heat performance, more durable.
- Professional outdoor painting, stainless steel components, giving excellent performance in anti-corrosion and anti-rusting, widely used in different environment.
- Light transmittance up to 94%, easy to improve in the future.



## FLOOD LIGHT SERIES

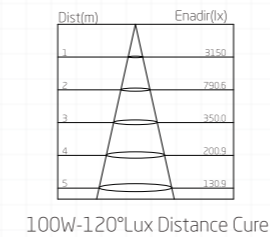
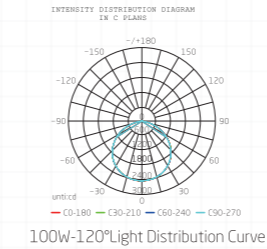

### Product Technical Parameters

Model	Luminous	Power factor	SPD
LV-UGR 10W	100lm/W	>0.9	>2KV
LV-UGR 20W	100lm/W	>0.9	>2KV
LV-UGR 30W	100lm/W	>0.9	>2KV
LV-UGR 50W	100lm/W	>0.9	>6KV
LV-UGR 100W	100lm/W	>0.9	>8KV
LV-UGR 150W	100lm/W	>0.9	>10KV
LV-UGR 200W	100lm/W	>0.9	>10KV

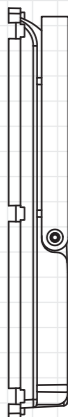
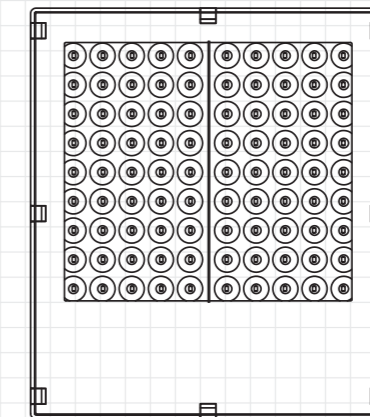

# FLOOD LIGHT

## CK SERIES

10W 20W 30W 50W 100W  
150W 200W 400W



## PRODUCT ADVANTAGES AND FEATURES

- Integrated cooling design, elegant, efficient.
- Streamline design, more beautiful appearance, no accumulation.
- ADC12# die-cast aluminum body, excellent heat performance, more durable.
- Professional outdoor painting, stainless steel components, giving excellent performance in anti-corrosion and anti-rusting, widely used in different environment.
- Light transmittance up to 94%, easy to improve in the future.



## FLOOD LIGHT SERIES

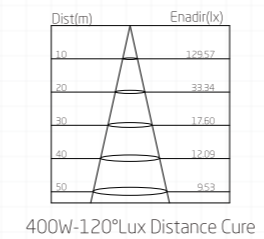
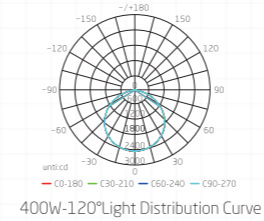

### Product Technical Parameters

Model	Luminous	Power factor	SPD
CK-10W	100lm/W	>0.9	>2KV
CK-20W	100lm/W	>0.9	>2KV
CK-30W	100lm/W	>0.9	>2KV
CK-50W	100lm/W	>0.9	>3KV
CK-100W	100lm/W	>0.9	>4KV
CK-150W	100lm/W	>0.9	>8KV
CK-200W	100lm/W	>0.9	>8KV
CK-400W	100lm/W	>0.9	>10KV

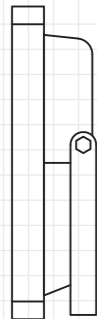
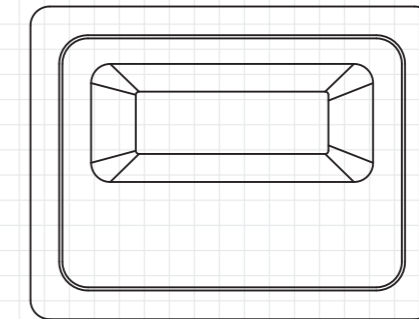



# HIGH BAY LIGHT

## HE SERIES

100W 150W 200W



### PRODUCT ADVANTAGES AND FEATURES

- Integrated cooling design, elegant, efficient.
- UFO design and Ultra thin design, Integrated Die-casting aluminum strengthen the heat dissipation
- Hight luminous efficiency, using Well-known band chip (San' an. OSRAM fo your options), Super high lumen efficiency and uniform lighting intensity



### HIGH BAY LIGHT SERIES

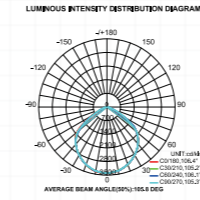

100W-Light Distribution Curve

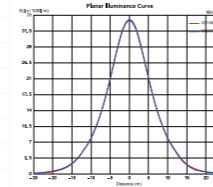

100W-Lux Distance Curve

#### Product Technical Parameters

Model	Luminous	Power factor	SPD
HE-100W	100-110lm/W	>0.9	>6KV
HE-150W	100-110lm/W	>0.9	>8KV
HE-200W	100-110lm/W	>0.9	>8KV

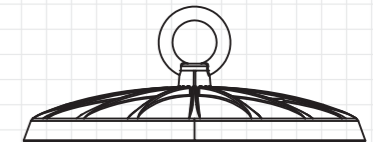
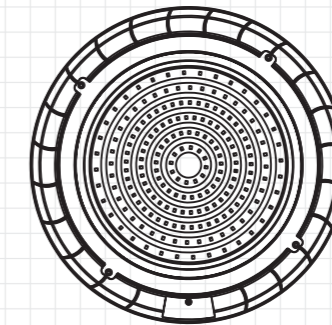
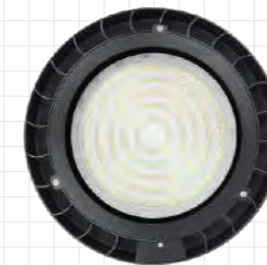



# HIGH BAY LIGHT

## HB SERIES

100W 150W 200W



### PRODUCT ADVANTAGES AND FEATURES

- Integrated cooling design, elegant, efficient.
- UFO design and Ultra thin design, Integrated Die-casting aluminum strengthen the heat dissipation.
- High luminous efficiency, using Well-known band chip (PHILIPS, OSRAM SAMSUNG for your options), Super high lumen efficiency and uniform lighting intensity.
- Using LIFUD/MEANWELL driver, giving out high long-term reliable performance driver.
- High performance, High PF, flicker free.
- IP65 waterproof, suitable wet & tough environment



### HIGH BAY LIGHT SERIES

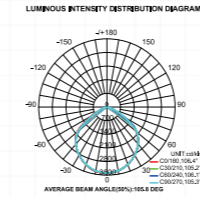

100W-Light Distribution Curve

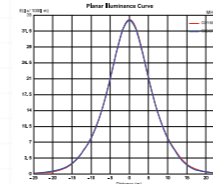

100W-Lux Distance Curve

#### Product Technical Parameters

Model	Luminous	Power factor	SPD
HB-100W	130-150lm/W	>0.9	>5KV
HB-150W	130-150lm/W	>0.9	>5KV
HB-200W	130-150lm/W	>0.9	>5KV

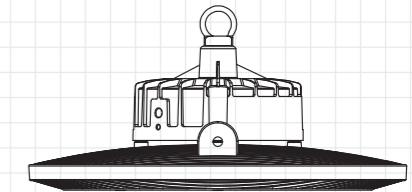
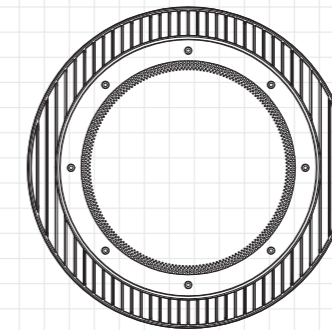
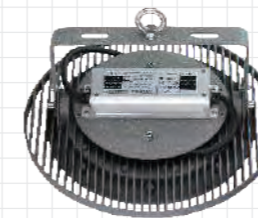
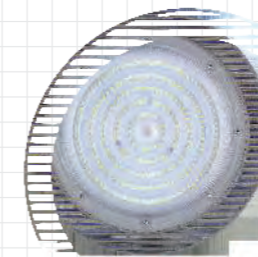

# HIGH BAY LIGHT

## HC SERIES

100W 150W 200W



### PRODUCT ADVANTAGES AND FEATURES

- Integrated cooling design, elegant, efficient.
- UFO design and Ultra thin design, Integrated Die-casting aluminum strengthen the heat dissipation.
- High luminous efficiency, using Well-known band chip (PHILIPS, OSRAM SAMSUNG for your options), Super high lumen efficiency and uniform lighting intensity.
- Using LIFUD/MEANWELL driver, giving out high long-term reliable performance driver.
- High performance, High PF, flicker free.
- IP65 waterproof, suitable wet & tough environment



### HIGH BAY LIGHT SERIES

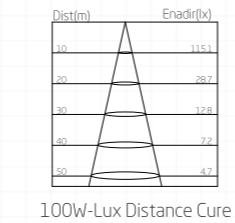
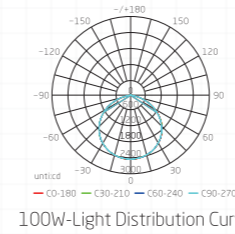

#### Product Technical Parameters

Model	Luminous	Power factor	SPD
HC-100W	130-150lm/W	>0.9	>5KV
HC-150W	130-150lm/W	>0.9	>5KV
HC-200W	130-150lm/W	>0.9	>5KV

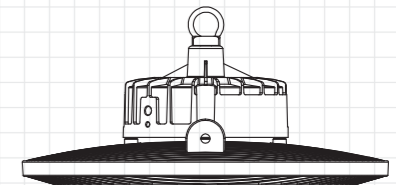
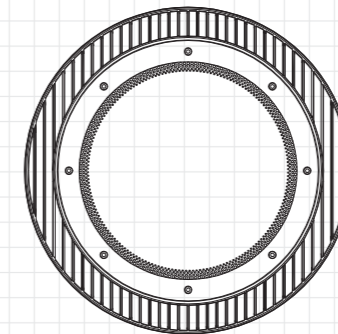

# COMPETITIV ADVANTAGE

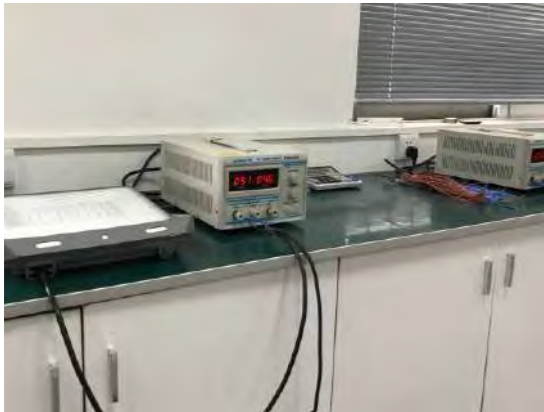
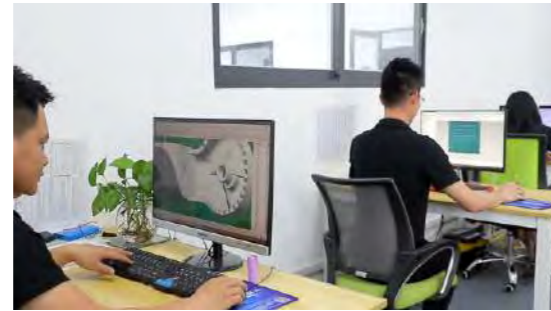
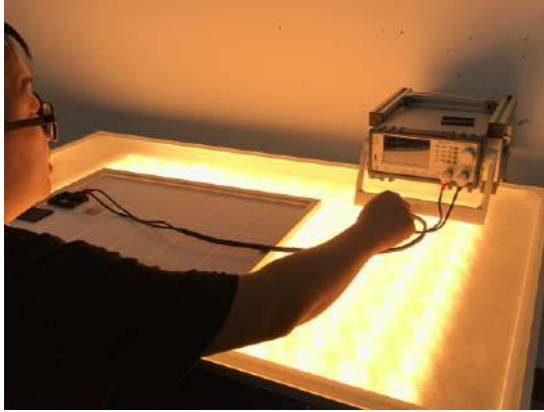

# SOLAR FLOOD LIGHT / PRODUCT INSTALLATION CASE



- 1. Croatia
- 2. BE Belgium
- 3. BR Brazil
- 4. IT Italy

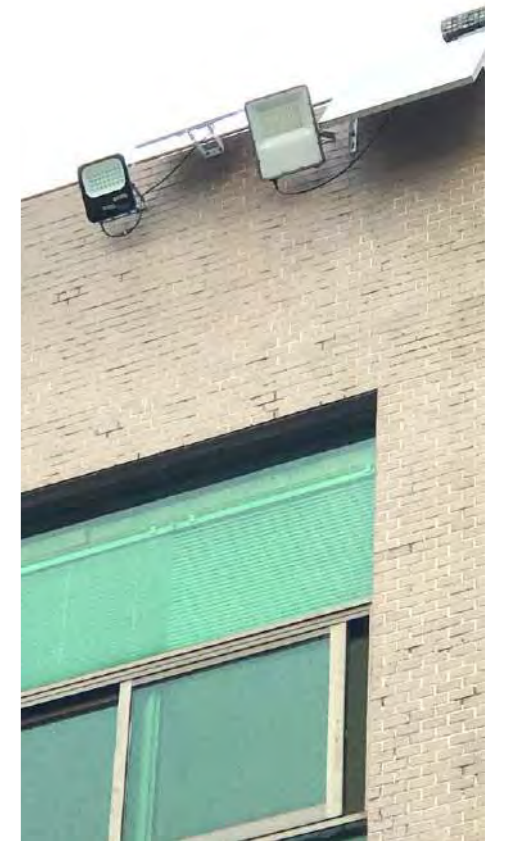
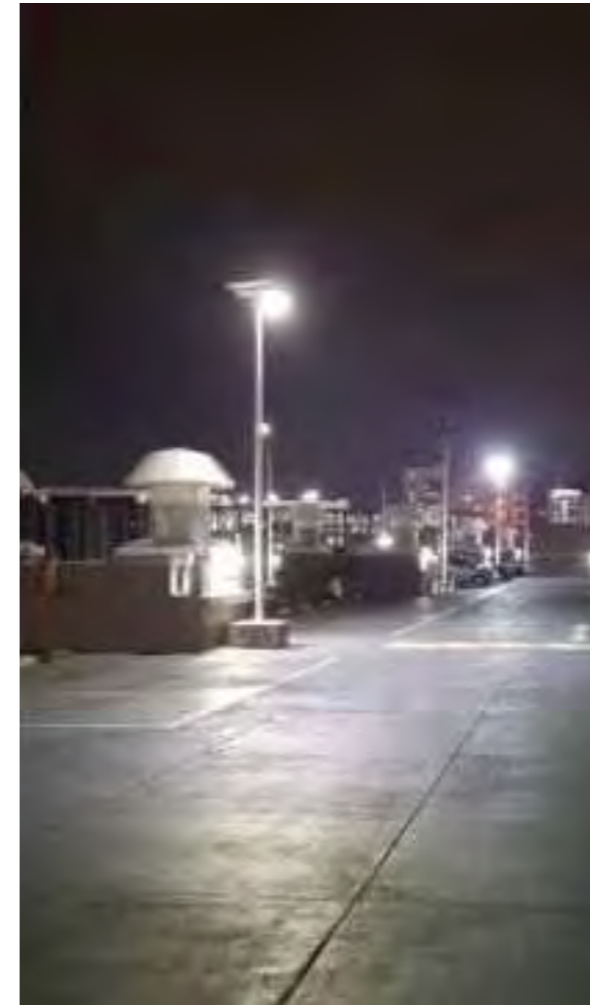

# SOLAR STREET LIGHT / PRODUCT INSTALLATION CASE



- 1. ES Spain
- 2. CA Canada
- 3. TN Tunisia
- 4. Russia
- 5. MY Malaysia

